

CENNÍK / PRICE LIST

SK 2020

 BEMETA®



|                |   |         |
|----------------|---|---------|
| <b>NOVINKA</b> | GAMMA   | 2 – 4   |
| <b>NOVINKA</b> | NIVA  | 5       |
| <b>NOVINKA</b> | VISTA   | 6       |
| <b>NOVINKA</b> | GALLA   | 7       |
|                | OMEGA   | 8 – 15  |
|                | WHITE   | 16 – 17 |
|                | DARK  | 18 – 20 |
|                | NERO  | 21 – 22 |
|                | NEO   | 23 – 25 |
|                | BETA  | 26 – 29 |
|                | TASI  | 30      |
|                | SOLO  | 31      |
|                | VIA   | 32 – 33 |
|                | PLAZA   | 34 – 35 |
|                | OVAL  | 36      |
|                | KERA  | 37      |
|                | RETRO   | 38 – 42 |
|                | NIKI  | 42      |
|                | ALFA  | 43      |
|                | TREND-i   | 44 – 45 |
|                | FIX   | 46      |
|                | RAWELL  | 47      |
|                | CYTRO   | 48 – 51 |
|                | SAMOSTATNE STOJACE DOPLNKY/FREESTANDING ACCESSORIES           | 52      |
|                | KOZMETICKÉ ZRKADLÁ A ZRKADLÁ<br>/COSMETIC MIRRORS AND MIRRORS | 53 – 57 |
|                | HOTEL/HOTEL EQUIPMENT   | 58 – 66 |
|                | SPRCHOVÝ PROGRAM/SHOWER PROGRAM                               | 67      |
|                | NÁHRADNÉ DIELY/SPARE PARTS                                    | 68 – 75 |
|                | HELP PROGRAM/HELP PROGRAM                                     | 76 – 86 |

NOVINKA **GAMMA**

Dostupné od júla 2020/Available from July, 2020

- chróm  
chróm
- polyresin  
polyresin
- čierna  
black
- biela  
white



NOVINKA

- **Vešiačik**  
Single robe hook  
15 x 42 x 43 mm  
145804022  
bez DPH      s DPH  
**16,0 €      19,2 €**



NOVINKA

- **Držiak toaletného papiera bez krytu**  
Paper holder without cover  
128 x 98 x 50 mm  
145812022  
bez DPH      s DPH  
**34,0 €      40,8 €**



NOVINKA

- **Držiak toaletného papiera s krytom**  
Paper holder with cover  
128 x 135 x 50 mm  
145812012  
bez DPH      s DPH  
**42,0 €      50,4 €**



NOVINKA

- **Mydlovnička s konzolou na stenu**  
Soap dish on the wall  
105 x 45 x 95 mm  
145408312  
bez DPH      s DPH  
**40,0 €      48,0 €**



NOVINKA

- **Mydlovnička s konzolou na stenu**  
Soap dish on the wall  
105 x 45 x 95 mm  
145508312  
bez DPH      s DPH  
**40,0 €      48,0 €**



NOVINKA

- **Dávkoč tekutého mydla s konzolou na stenu**  
Soap dish on the wall  
115 x 115 x 95 mm, 200 ml  
145409012  
bez DPH      s DPH  
**58,0 €      69,6 €**



NOVINKA

- **Dávkoč tekutého mydla s konzolou na stenu**  
Soap dish on the wall  
115 x 115 x 95 mm, 200 ml  
145509012  
bez DPH      s DPH  
**58,0 €      69,6 €**



NOVINKA

- **WC kefa s konzolou na stenu**  
Toilet brush on the wall, square  
125 x 386 x 105 mm  
145413092  
bez DPH      s DPH  
**78,0 €      93,6 €**



NOVINKA

- **WC kefa s konzolou na stenu**  
Toilet brush on the wall, square  
125 x 386 x 105 mm  
145513092  
bez DPH      s DPH  
**78,0 €      93,6 €**



NOVINKA

- **Držiak na zubné kefy s konzolou na stenu**  
Toothbrush holder, on the wall, square  
115 x 115 x 95 mm  
145411012  
bez DPH      s DPH  
**40,0 €      48,0 €**



NOVINKA

- **Držiak na zubné kefy s konzolou na stenu**  
Toothbrush holder, on the wall, square  
115 x 115 x 95 mm  
145511012  
bez DPH      s DPH  
**40,0 Kč      48,0 €**



NOVINKA

■ **Držiak toaletného papiera**

Paper holder without cover

180 x 36 x 65 mm

145812222

bez DPH s DPH

**25,0 € 30,0 €**



NOVINKA

■ **Mydlovnička na postavenie**

Soap dish holder, free standing

95 x 15 x 95 mm

145608310

bez DPH s DPH

**10,0 € 12,0 €**



NOVINKA

■ **Mydlovnička na postavenie**

Soap dish holder, free standing

95 x 15 x 95 mm

145708314

bez DPH s DPH

**10,0 € 12,0 €**



NOVINKA

■ **Držiak na zubné kefky na postavenie**

Toothbrush holder, free standing

75 x 115 x 75 mm

145611310

bez DPH s DPH

**11,9 € 14,3 €**



NOVINKA

■ **Držiak na zubné kefky na postavenie**

Toothbrush holder, free standing

75 x 115 x 75 mm

145711314

bez DPH s DPH

**11,9 € 14,3 €**



NOVINKA

■ **Dávkač tekutého mydla na postavenie**

Soap dispenser, free standing

75 x 160 x 86 mm, 200 ml

145609310

bez DPH s DPH

**30,2 € 36,3 €**



NOVINKA

■ **Dávkač tekutého mydla na postavenie**

Soap dispenser, free standing

75 x 160 x 86 mm, 200 ml

145709314

bez DPH s DPH

**30,2 € 36,3 €**



NOVINKA

■ **WC kefa na položenie**

Toilet standing brush, free standing

92 x 385 x 92 mm

145613310

bez DPH s DPH

**34,2 € 41,0 €**



NOVINKA

■ **WC kefa na položenie**

Toilet standing brush, free standing

92 x 385 x 92 mm

145713314

bez DPH s DPH

**34,2 € 41,0 €**



NOVINKA

■ **Polička sklenená**

Glass shelf

600 x 36 x 90 mm

145802312

bez DPH s DPH

**68,0 € 81,6 €**

# NOVIINKA GAMMA

Dostupné od júla 2020/Available from July, 2020

- chróm  
chróm
- polyresin  
polyresin
- čierna  
black
- biela  
white



NOVIINKA

- **Mydlovnička na postavenie**  
Soap dish holder, free standing  
110 x 25 x 110 mm  
145608320  
bez DPH      s DPH  
**10,0 €      12,0 €**



NOVIINKA

- **Mydlovnička na postavenie**  
Soap dish holder, free standing  
110 x 25 x 110 mm  
145708324  
bez DPH      s DPH  
**10,0 €      12,0 €**



NOVIINKA

- **Dávkovač tekutého mydla na postavenie**  
Soap dispenser, free standing  
72 x 175 x 86 mm, 250 ml  
145609320  
bez DPH      s DPH  
**16,3 €      19,5 €**



NOVIINKA

- **Dávkovač tekutého mydla na postavenie**  
Soap dispenser, free standing  
72 x 175 x 86 mm, 250 ml  
145709324  
bez DPH      s DPH  
**16,3 €      19,5 €**



NOVIINKA

- **WC kefa na položenie**  
Toilet standing brush, free standing  
98 x 455 x 98 mm  
145613310  
bez DPH      s DPH  
**34,2 €      41,0 €**



NOVIINKA

- **WC kefa na položenie**  
Toilet standing brush, free standing  
98 x 455 x 98 mm  
145713314  
bez DPH      s DPH  
**34,2 €      41,0 €**



NOVIINKA

- **Držiak na zubné kefky na postavenie**  
Toothbrush holder, free standing  
72 x 120 x 72 mm  
145611320  
bez DPH      s DPH  
**10,8 €      13,0 €**



NOVIINKA

- **Držiak na zubné kefky na postavenie**  
Toothbrush holder, free standing  
72 x 120 x 72 mm  
145711324  
bez DPH      s DPH  
**10,8 €      13,0 €**



NOVIINKA

- **Držiak uterákov**  
Towel holder  
300 x 36 x 65 mm  
145804012  
bez DPH      s DPH  
**36,0 €      43,2 €**



NOVIINKA

- **Držiak uterákov**  
Towel holder  
600 x 36 x 65 mm  
145804042  
bez DPH      s DPH  
**50,0 €      60,0 €**



NOVIINKA

- **Dvojité držiak uterákov, otočný**  
Double swing arm towel holder  
40 x 65 x 420 mm  
145804102  
bez DPH      s DPH  
**60,0 €      72,0 €**



■ **Vešiacik dvojité**  
Double robe hook  
48 x 85 x 22 mm  
101106035  
bez DPH      s DPH  
**6,7 €      8,0 €**

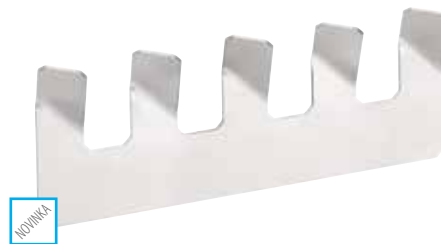

■ **Hrazda s 5 vešiacikmi**  
Rail with 5 robe hooks  
180 x 70 x 22 mm  
101106045  
bez DPH      s DPH  
**15,7 €      18,8 €**



■ **Držiak toaletného papiera**  
Paper holder  
155 x 58 x 83 mm  
101106025  
bez DPH      s DPH  
**13,3 €      16,0 €**



■ **Držiak toaletného papiera s poličkou**  
Toilet paper holder with shelf  
270 x 58 x 83 mm  
101104015  
bez DPH      s DPH  
**19,8 €      23,8 €**

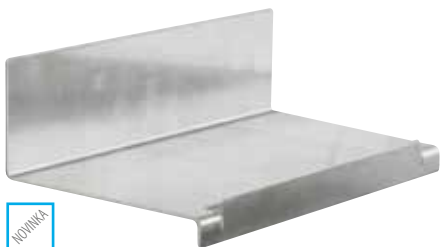

■ **Polička**  
Shelf  
180 x 62 x 97 mm  
101102365  
bez DPH      s DPH  
**17,1 €      20,5 €**



■ **Polička**  
Shelf  
300 x 62 x 97 mm  
101102225  
bez DPH      s DPH  
**22,2 €      26,6 €**



■ **Držiak uterákov**  
Towel holder  
335 x 50 x 70 mm  
101112135  
bez DPH      s DPH  
**20,5 €      24,6 €**



■ **WC kefa na zavesenie**  
Wall mounted toilet brush  
130 x 353 x 120 mm  
101113091  
bez DPH      s DPH  
**40,8 €      49,0 €**

polyresin  
polyresin

číra, biela  
clear, white

číra, čierna  
clear, black

číra, modrá  
clear, blau

číra, béžová  
clear, beige



NOVINKA

- Mydlovnička na postavenie  
Soap dish holder, free standing  
110 x 30 x 70 mm  
120108196-104  
bez DPH 9,8 € s DPH 11,7 €



NOVINKA

- Mydlovnička na postavenie  
Soap dish holder, free standing  
110 x 30 x 70 mm  
120108196-100  
bez DPH 9,8 € s DPH 11,7 €



NOVINKA

- Mydlovnička na postavenie  
Soap dish holder, free standing  
110 x 30 x 70 mm  
120108196-102  
bez DPH 9,8 € s DPH 11,7 €



NOVINKA

- Mydlovnička na postavenie  
Soap dish holder, free standing  
110 x 30 x 70 mm  
120108196-101  
bez DPH 9,8 € s DPH 11,7 €



NOVINKA

- Držiak na zubné kefy na postavenie  
Toothbrush holder, free standing  
72 x 110 x 72 mm  
120111026-104  
bez DPH 12,3 € s DPH 14,7 €



NOVINKA

- Držiak na zubné kefy na postavenie  
Toothbrush holder, free standing  
72 x 110 x 72 mm  
120111026-100  
bez DPH 12,3 € s DPH 14,7 €



NOVINKA

- Držiak na zubné kefy na postavenie  
Toothbrush holder, free standing  
72 x 110 x 72 mm  
120111026-102  
bez DPH 12,3 € s DPH 14,7 €



NOVINKA

- Držiak na zubné kefy na postavenie  
Toothbrush holder, free standing  
72 x 110 x 72 mm  
120111026-101  
bez DPH 12,3 € s DPH 14,7 €



NOVINKA

- Dávkovač tekutého mydla na postavenie  
Soap dispenser, free standing  
72 x 110 x 72 mm, 250 ml  
120109016-104  
bez DPH 17,0 € s DPH 20,4 €



NOVINKA

- Dávkovač tekutého mydla na postavenie  
Soap dispenser, free standing  
72 x 110 x 72 mm, 250 ml  
120109016-100  
bez DPH 17,0 € s DPH 20,4 €



NOVINKA

- Dávkovač tekutého mydla na postavenie  
Soap dispenser, free standing  
72 x 110 x 72 mm, 250 ml  
120109016-102  
bez DPH 17,0 € s DPH 20,4 €



NOVINKA

- Dávkovač tekutého mydla na postavenie  
Soap dispenser, free standing  
72 x 110 x 72 mm, 250 ml  
120109016-101  
bez DPH 17,0 € s DPH 20,4 €



NOVINKA

- WC kefa na polozenie  
Toilet standing brush, free standing  
100 x 370 x 100 mm  
120113316-104  
bez DPH 26,3 € s DPH 31,6 €



NOVINKA

- WC kefa na polozenie  
Toilet standing brush, free standing  
100 x 370 x 100 mm  
120113316-100  
bez DPH 26,3 € s DPH 31,6 €



NOVINKA

- WC kefa na polozenie  
Toilet standing brush, free standing  
100 x 370 x 100 mm  
120113316-102  
bez DPH 26,3 € s DPH 31,6 €



NOVINKA

- WC kefa na polozenie  
Toilet standing brush, free standing  
100 x 370 x 100 mm  
120113316-101  
bez DPH 26,3 € s DPH 31,6 €



chróm chróm lesk polished nerez stainless mat mat polyresin polyresin



■ **Vešiačik**  
Single robe hook  
20 x 60 x 46 mm  
108106020  
bez DPH s DPH  
**13,7 € 16,5 €**



■ **Držiak toaletného papiera bez krytu**  
Paper holder without cover  
20 x 60 x 46 mm  
108112030  
bez DPH s DPH  
**23,2 € 27,9 €**



■ **Mýdlenka**  
Glass soap dish  
87 x 32 x 105 mm  
108108020  
bez DPH s DPH  
**17,8 € 21,4 €**



■ **Držiak na zubné kefky**  
Holder with glass  
75 x 123 x 99 mm  
108110010  
bez DPH s DPH  
**30,9 € 37,1 €**



■ **Dvojitý držiak na zubné kefky**  
Toothbrush holder with glasses  
170 x 123 x 79 mm  
108110020  
bez DPH s DPH  
**47,9 € 57,4 €**



■ **WC kefa**  
Toilet brush holder  
105 x 360 x 119 mm  
108113010\*  
bez DPH s DPH  
**51,5 € 61,8 €**



■ **Dávkovač tekutého mydla**  
Soap dispenser  
75 x 170 x 130 mm, 230 ml  
108109010  
bez DPH s DPH  
**48,0 € 57,6 €**



■ **Kruh**  
Ring towel holder  
168 x 188 x 50 mm  
108104060  
bez DPH s DPH  
**29,1 € 35,0 €**



■ **Držiak uterákov**  
Towel holder  
600 x 20 x 59 mm  
108104040  
bez DPH s DPH  
**43,0 € 51,6 €**



■ **Dvojitý držiak uterákov**  
Double towel holder  
600 x 20 x 104 mm  
108104050  
bez DPH s DPH  
**65,3 € 78,3 €**



■ **Polička na uteráky**  
Towel rack  
600 x 20 x 200 mm  
108105080  
bez DPH s DPH  
**103,2 € 123,9 €**

\* čierna kefa/black brush

# OMEGA

mosadz  
brass

chróm  
chrome

lesk  
shiny

sklo  
glass



- **Vešiacik**  
Single robe hook  
55 x 55 x 50 mm  
104106022  
bez DPH 8,5 €    s DPH 10,2 €



- **Vešiacik dvojity**  
Double robe hook  
55 x 55 x 50 mm  
104106032  
bez DPH 10,2 €    s DPH 12,2 €



- **Vešiacik**  
Single robe hook  
ø 16 x 30 mm    bez DPH 3,2 €    s DPH 3,8 €  
104506092  
ø 16 x 55 mm    bez DPH 3,4 €    s DPH 4,0 €  
104506082



- **Vešiacik**  
Single robe hook  
ø 15 x 35 mm    bez DPH 2,8 €    s DPH 3,3 €  
104206023  
ø 25 x 50 mm    bez DPH 3,8 €    s DPH 4,5 €  
104206024



- **Vešiacik valcový**  
Single robe hook  
55 x 55 x 55 mm  
104106062  
bez DPH 7,5 €    s DPH 9,0 €



- **Vešiacik**  
Single robe hook  
55 x 55 x 70 mm  
104206022  
bez DPH 11,3 €    s DPH 13,5 €



- **Vešiacik**  
Robe hook  
55 x 110 x 60 mm  
104105242  
bez DPH 15,0 €    s DPH 18,0 €



- **Vešiacik s držiakom**  
Robe hook  
55 x 115 x 60 mm  
104105252  
bez DPH 16,8 €    s DPH 20,2 €



- **Věšáček dvojity**  
Double robe hook  
84 x 60 x 66 mm  
104206032  
bez DPH 12,3 €    s DPH 14,8 €



- **Držiak toaletného papiera bez krytu**  
Paper holder without cover  
170 x 55 x 70 mm  
104212032    pravý/right  
104212032L    ľavý/left  
bez DPH 20,6 €    s DPH 24,7 €



- **Držiak toaletného papiera rezervný**  
Spare toilet paper holder  
55 x 165 x 65 mm  
104112032  
bez DPH 16,1 €    s DPH 19,3 €



- **Držiak toaletného papiera rezervný, na 2 role**  
Spare paper holder, extended  
55 x 314 x 65 mm  
104112142  
bez DPH 18,5 €    s DPH 22,2 €



- **Dvojity držiak toaletného papiera**  
Double paper holder  
385 x 55 x 85 mm  
104201072  
bez DPH 37,8 €    s DPH 45,4 €



- **Držiak toaletného papiera s krytom**  
Paper holder with cover  
142 x 170 x 90 mm  
104212012  
bez DPH 26,1 €    s DPH 31,3 €

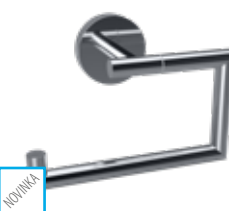

- **Držiak toaletného papiera bez krytu**  
Paper holder without cover  
150 x 105 x 67 mm  
199112042  
bez DPH 22,2 €    s DPH 26,6 €



- **Držiak toaletného papiera bez krytu**  
Paper holder without cover  
140 x 95 x 90 mm  
104112042    ľavý/left  
104112042R    pravý/right  
bez DPH 17,8 €    s DPH 21,4 €



■ Držák toaletného papíru dvojitý s krytom

Double paper holder with cover

270 x 140 x 107 mm  
104112092

bez DPH s DPH  
**49,9 € 59,8 €**



■ Držiak toaletného papiera s krytom

Paper holder with cover

140 x 155 x 80 mm  
104112012 ľavý/left

104112012R pravý/right  
bez DPH s DPH  
**22,3 € 26,8 €**



■ WC kefa valcová malá na zavesenie

Wall mounted toilet brush

95 x 385 x 120 mm  
104913112\*/104913117\*\*

bez DPH s DPH  
**37,5 € 45,0 €**



■ WC kefa valcová malá na zavesenie

Wall mounted toilet brush

90 x 385 x 90 mm  
104913122

bez DPH s DPH  
**28,0 € 33,6 €**



■ WC kefa valcová na položenie

Free standing toilet brush holder

90 x 365 x 90 mm  
104913152

bez DPH s DPH  
**22,8 € 27,4 €**



■ WC kefa valcová na položenie

Free standing toilet brush holder

90 x 385 x 90 mm  
104913092

bez DPH s DPH  
**30,9 € 37,1 €**



■ WC kefa na položenie

Free standing toilet brush holder

110 x 400 x 130 mm  
104113102\*/104113107\*\*

bez DPH s DPH  
**20,6 € 24,78 €**



■ WC kefa na zavesenie, miska sklo

Wall mounted toilet brush with glass dish

95 x 370 x 140 mm  
104113012\*/104113017\*\*

bez DPH s DPH  
**26,1 € 31,3 €**



■ Stojan s držiakom na toal. papier a WC kefu

Free standing toilet paper and brush holder

250 x 730 x 250 mm  
104836012

bez DPH s DPH  
**112,4 € 134,9 €**



■ WC kefa na položenie alebo zavesenie

Toilet brush holder free standing or hanging

95 x 380 x 105 mm  
102313066\*/102313067\*\*

bez DPH s DPH  
**37,4 € 44,9 €**



■ WC kefa valcová na položenie

Toilet brush holder, free standing

95 x 380 x 105 mm  
102313056\*/102313057\*\*

bez DPH s DPH  
**37,4 € 44,9 €**



■ Dávkovač tekutého mydla, sklo

Soap dispenser, glass

80 x 190 x 133 mm, 230 ml  
104109017

bez DPH s DPH  
**35,7 € 42,9 €**

# OMEGA

mosadz  
brass

chróm  
chrome

lesk  
shiny

sklo  
glass

NOVINKA

## ■ Dávkoč tekutého mydla

Soap dispenser, glass

85 x 114 x 100 mm, 200 ml  
104309322

bez DPH s DPH  
41,0 € 49,2 €



## ■ Dávkoč tekutého mydla MINI

Soap dispenser, MINI glass

75 x 145 x 100 mm, 200 ml  
104109102

bez DPH s DPH  
26,1 € 31,3 €



## ■ Dávkoč tekutého mydla, chróm

Soap dispenser

55 x 175 x 85 mm, 150 ml  
104109012

bez DPH s DPH  
33,3 € 40,0 €



## ■ Dávkoč tekutého mydla plný úchyt

Soap dispenser

55 x 195 x 85 mm, 150 ml  
104609172

bez DPH s DPH  
37,1 € 44,5 €



## ■ Dávkoč tekutého mydla JUMBO

Soap dispenser JUMBO

70 x 230 x 110 mm, 550 ml  
104109032

bez DPH s DPH  
73,9 € 88,7 €



## ■ Dávkoč tekutého mydla s magnetickou mydlovničkou

Soap dispenser with magnetic soap holder, glass

75 x 160 x 100 mm, 200 ml  
104109182

bez DPH s DPH  
44,7 € 53,7 €



## ■ Dávkoč tekutého mydla s plastovou pumpičkou MINI

Soap dispenser, MINI glass

75 x 160 x 100 mm, 200 ml  
138709041

bez DPH s DPH  
30,9 € 37,1 €



## ■ Mydlovnička sklenená

Glass soap dish

110 x 55 x 105 mm  
104108042

bez DPH s DPH  
15,8 € 18,9 €



## ■ Mydlovnička obdĺžniková

Soap dish metallic

125 x 55 x 115 mm  
104208082

bez DPH s DPH  
17,2 € 20,6 €



## ■ Mydlovnička obdĺžniková, drôtená

Soap dish basket

140 x 55 x 125 mm  
104108162

bez DPH s DPH  
18,8 € 22,5 €



## ■ Mydlovnička magnetická

Magnetic soap holder

55 x 55 x 70 mm  
104108202

bez DPH s DPH  
16,8 € 20,2 €



## ■ Držiak na zubné kefky

Toothbrush holder

105 x 55 x 85 mm  
104110032

bez DPH s DPH  
15,0 € 18,0 €



## ■ Mydlovnička, polička, lesk

Soap dish polished surface

270 x 40 x 110 mm  
146102272

bez DPH s DPH  
49,2 € 59,10 €



## ■ Držiak na zubné kefky, sklo

Holder with glass

70 x 95 x 105 mm  
104110012

bez DPH s DPH  
15,0 € 18,0 €



## ■ Dvojitý držiak na zubné kefky, sklo

Double glass holder

160 x 95 x 90 mm  
104110022

bez DPH s DPH  
26,1 € 31,3 €



## ■ Dvojitý držiak na zubné kefky, sklo

Toothbrush holder with glasses

190 x 95 x 125 mm  
104110042

bez DPH s DPH  
37,4 € 44,9 €



■ Trojháčik otočný  
Swing arm triple hook  
55 x 190 x 135 mm  
104206072  
bez DPH s DPH  
22,7 € 27,2 €



■ Dávkovač tekutého mydla na postavenie  
Soap dispenser free standing  
80 x 160 x 80 mm, 200 ml  
138109161  
bez DPH s DPH  
30,9 € 37,1 €



■ Držiak na zubné kefky, sklo, na postavenie  
Single glass holder with glass free standing  
80 x 100 x 80 mm  
138110061  
bez DPH s DPH  
16,8 € 20,2 €



■ Mydlovnička sklenená na postavenie  
Soap dish holder free standing  
110 x 60 x 110 mm  
138108191  
bez DPH s DPH  
16,8 € 20,2 €



■ Trojháčik otočný  
Swing arm triple hook  
55 x 85 x 95 mm  
104106072  
bez DPH s DPH  
22,0 € 26,4 €



■ Dvojháčik vysoký  
Double hook  
55 x 120 x 90 mm  
104405222  
bez DPH s DPH  
22,3 € 26,8 €



■ Hrazda s 5 vešiacikmi  
Rail with 5 robe hooks  
415 x 55 x 70 mm  
104105112  
bez DPH s DPH  
24,8 € 29,7 €



■ Štvorháčik  
Rail with 4 robe hooks  
270 x 25 x 40 mm  
104606102  
bez DPH s DPH  
18,9 € 22,6 €



■ Šestháčik  
Rail with 6 robe hooks  
410 x 25 x 40 mm  
104606112  
bez DPH s DPH  
22,7 € 27,2 €



■ Držiak na utierky  
Double hook  
120 x 55 x 50 mm  
104405202  
bez DPH s DPH  
18,5 € 22,2 €



■ Trojháčik  
Triple hook  
185 x 55 x 50 mm  
104405232  
bez DPH s DPH  
26,1 € 31,3 €



■ Štvorháčik  
4 robe hooks  
250 x 55 x 50 mm  
104405212  
bez DPH s DPH  
35,7 € 42,9 €



■ Držák kuchynských utěrek  
Kitchen roll holder  
295 x 100 x 62 mm  
146403152  
bez DPH s DPH  
24,0 € 28,8 €



■ Pevný držiak uterákov  
Double towel holder  
50 x 90 x 365 mm  
104704142  
bez DPH s DPH  
20,6 € 24,7 €



■ Držiak uterákov v kotúči s dávkovačom tekutého mydla  
Kitchen roll and soap dispenser holder  
104019012 455 x 180 x 115 mm, 230 ml  
bez DPH s DPH  
54,3 € 65,2 €

# OMEGA

mosadz  
brass

chróm  
chrome

lesk  
shiny

sklo  
glass



- Kruh  
Ring towel holder  
160 x 165 x 65 mm  
104204062  
bez DPH s DPH  
**18,9 € 21,6 €**



- Kruh  
Ring towel holder  
160 x 190 x 55 mm  
104104062  
bez DPH s DPH  
**17,2 € 20,6 €**



- Dvojitý držiak uterákov otočný  
Double swing arm towel holder  
55 x 165 x 450 mm  
104204102  
bez DPH s DPH  
**28,6 € 34,3 €**



- Trojitý držiak uterákov, otočný  
Three swing arm towel holder  
55 x 195 x 450 mm  
104204112  
bez DPH s DPH  
**41,3 € 49,5 €**

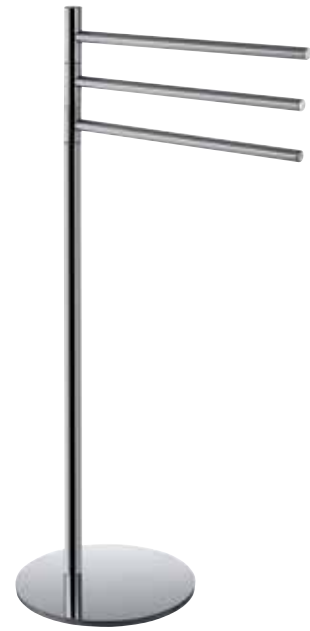

- Stojan s držiakom uterákov, trojitý otočný  
Free standing 3 swing arm towel stand  
370 x 850 x 250 mm  
104836032  
bez DPH s DPH  
**123,6 € 148,3 €**



- Dvojitý držiak uterákov, otočný na jednej rúčke  
Double swing arm towel holder  
55 x 40 x 420 mm  
104204191  
bez DPH s DPH  
**26,4 € 31,7 €**



- Držiak uterákov  
Towel holder

|           |                  | bez DPH | s DPH  |
|-----------|------------------|---------|--------|
| 104104012 | 355 x 55 x 65 mm | 17,2 €  | 20,6 € |
| 104104022 | 505 x 55 x 65 mm | 21,6 €  | 26,0 € |
| 104104042 | 655 x 55 x 65 mm | 24,7 €  | 29,6 € |



- Dvojitý držiak uterákov  
Double towel holder  
655 x 55 x 110 mm  
104104052  
bez DPH s DPH  
**28,9 € 34,6 €**



- Polička na uteráky  
Towel rack  
655 x 55 x 200 mm  
104105082  
bez DPH s DPH  
**41,6 € 50,0 €**



- Polička na uteráky s hrazdou  
Towel rack  
655 x 110 x 200 mm  
104105072  
bez DPH s DPH  
**45,4 € 54,5 €**



- Držiak uterákov  
Towel holder

|           |                  | bez DPH | s DPH  |
|-----------|------------------|---------|--------|
| 104204332 | 354 x 54 x 65 mm | 28,5 €  | 34,2 € |
| 104204342 | 653 x 54 x 65 mm | 36,0 €  | 43,2 € |



- **Držiak uterákov na sklenené dvere**  
Towel rack for glass door  
520 x 20 x 133 mm  
104204352  
bez DPH s DPH  
**46,9 € 56,3 €**



- **Držiak uterákov**  
Towel holder
- |           |                  | bez DPH | s DPH  |
|-----------|------------------|---------|--------|
| 104204012 | 355 x 55 x 65 mm | 22,3 €  | 26,8 € |
| 104204022 | 505 x 55 x 65 mm | 26,1 €  | 31,3 € |
| 104204042 | 655 x 55 x 65 mm | 30,9 €  | 37,0 € |
| 104204262 | 855 x 55 x 65 mm | 35,0 €  | 42,0 € |



- **Dvojitý držiak uterákov**  
Double towel holder
- |           |                   | bez DPH | s DPH  |
|-----------|-------------------|---------|--------|
| 104204052 | 655 x 55 x 120 mm | 37,4 €  | 44,9 € |
| 104204272 | 855 x 55 x 120 mm | 60,0 €  | 72,0 € |



- **Polička na uteráky**  
Towel rack  
655 x 55 x 215 mm  
104205082  
bez DPH s DPH  
**49,2 € 59,1 €**



- **Polička na uteráky výklopná**  
Tiltable towel rack  
655 x 55 x 270 mm  
104205152  
bez DPH s DPH  
**72,6 € 87,1 €**



- **Polička na uteráky s hrazdou**  
Towel rack with rail
- |           |                    | bez DPH | s DPH  |
|-----------|--------------------|---------|--------|
| 104205072 | 655 x 110 x 215 mm | 67,8 €  | 81,3 € |
| 104219072 | 550 x 120 x 265 mm | 66,3 €  | 79,6 € |

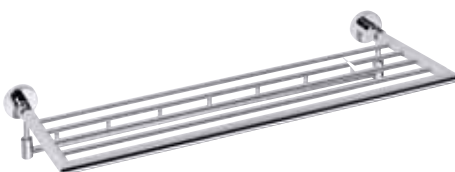

- **Polička na uteráky výklopná s háčikmi**  
Tiltable towel rack with hooks  
655 x 105 x 270 mm  
104205162  
bez DPH s DPH  
**87,4 € 104,9 €**



- **Polička na uteráky, dvojitá s hrazdou**  
Double towel rack with rail  
655 x 160 x 225 mm  
104205102  
bez DPH s DPH  
**76,3 € 91,6 €**



- **Polička na uteráky, typ U s hrazdou**  
"U" type double towel rack  
655 x 155 x 270 mm  
104205172  
bez DPH s DPH  
**73,9 € 88,6 €**



- **Polička sklenená**  
Glass shelf  
600 x 55 x 130 mm  
104102042  
bez DPH s DPH  
**24,0 € 28,8 €**



- **Polička sklenená**  
Glass shelf  
600 x 65 x 130 mm  
104202042  
bez DPH s DPH  
**29,2 € 35,0 €**



- **Polička sklenená**  
Glass shelf  
300 x 55 x 130 mm  
104122042  
bez DPH s DPH  
**20,5 € 24,6 €**



- **Polička sklenená, rohová**  
Glass shelf, corner model  
255 x 55 x 255 mm  
104102012  
bez DPH s DPH  
**25,0 € 30,0 €**

# OMEGA

mosadz  
brass

chróm  
chrome

lesk  
shiny

sklo  
glass



■ Polička sklenená, s výklopnou hrazdou

Glass shelf with tilttable rail

300 x 55 x 130 mm

104102202

bez DPH s DPH

35,6 € 42,8 €



■ Polička sklenená, s výklopnou hrazdou

Glass shelf with tilttable rail

600 x 55 x 130 mm

104102212

bez DPH s DPH

41,2 € 49,4 €



■ Polička sklenená, rohová s hrazdou

Glass shelf with rail, corner model

255 x 70 x 255 mm

104202162

bez DPH s DPH

32,0 € 38,4 €



■ Polička sklenená, dvojité, s hrazdou

Double glass shelf

400 x 385 x 115 mm

104202122

bez DPH s DPH

70,4 € 84,5 €



■ Polička sklenená, dvojité rohová s hrazdou

Double glass shelf, corner model

280 x 380 x 280 mm

104202142

bez DPH s DPH

67,8 € 81,3 €



■ Polička sklenená, trojitá s hrazdou

Triple glass shelf

400 x 665 x 130 mm

104202132

bez DPH s DPH

93,3 € 111,9 €



■ Polička sklenená, trojitá rohová s hrazdou

Triple glass shelf, corner model

270 x 660 x 270 mm

104202152

bez DPH s DPH

88,1 € 105,7 €



■ Držiak na poličku, bez skla, pár

Glass shelf holder without glass, pair

104502112 19 x 19 x 28 mm, ≠ 6 mm

bez DPH s DPH  
13,3 € 16,0 €

104502112 19 x 19 x 28 mm, ≠ 8 mm  
13,3 € 16,0 €

104102112 55 x 55 x 40 mm, ≠ 6 mm  
19,6 € 23,5 €

104102112 55 x 55 x 40 mm, ≠ 8 mm  
19,6 € 23,5 €



■ Držiaky na výklopné zrkadlo

Tilttable mirror holders

55 x 78 x 90 mm, ≠ 6 mm

301501131

bez DPH s DPH

28,5 € 34,2 €



■ Držiak fény, špirálový

Hair dryer holder, spiral

100 x 130 x 125 mm

104117022

bez DPH s DPH

18,5 € 22,2 €



■ Držiak fény

Hair dryer holder

80 x 55 x 100 mm

101117012

bez DPH s DPH

17,2 € 20,6 €



■ Redukcia úchytky pre lepenie na sklo\*\*\*

Back plate for gluing accessories on glass\*\*\*

55 x 55 x 14 mm

131567152

bez DPH s DPH

5,5 € 6,6 €



■ Vešička na dvere

Over door hook

20 x 70 x 40 mm

104106152

bez DPH s DPH

15,4 € 18,5 €



■ Zásobník na odličovacie tampóny

Cotton pad dispenser

65 x 205 x 115 mm

146503172

bez DPH s DPH

23,0 € 27,6 €



■ Stierka do sprchy

Shower door wiper

265 x 175 x 55 mm

104237012

bez DPH s DPH

24,1 € 28,9 €

\*\*\* Lepidlo nie je súčasťou balenia./Glue is not included.





■ Držadlo pevné  
Bath grab bar

|           |                  |               |               |
|-----------|------------------|---------------|---------------|
| 102307012 | 355 x 55 x 75 mm | bez DPH       | s DPH         |
|           |                  | <b>25,8 €</b> | <b>30,9 €</b> |
| 102307052 | 500 x 55 x 65 mm | <b>26,5 €</b> | <b>31,7 €</b> |



■ Držadlo lomené  
Bath grab bar angled

|                   |           |               |               |
|-------------------|-----------|---------------|---------------|
| 460 x 250 x 80 mm | 102307022 | bez DPH       | s DPH         |
|                   |           | <b>40,5 €</b> | <b>48,6 €</b> |



■ Držadlo lomené s mydlovničkou  
Bath grab bar angled with soap basket

|                    |           |               |               |
|--------------------|-----------|---------------|---------------|
| 400 x 200 x 130 mm | 102307032 | bez DPH       | s DPH         |
|                    |           | <b>48,1 €</b> | <b>57,8 €</b> |



■ Držadlo pevné  
Bath grab bar

|                  |           |               |               |
|------------------|-----------|---------------|---------------|
| 350 x 50 x 75 mm | 104307611 | bez DPH       | s DPH         |
|                  |           | <b>35,7 €</b> | <b>42,9 €</b> |



■ Držadlo lomené  
Bath grab bar angled

|                   |           |               |               |
|-------------------|-----------|---------------|---------------|
| 412 x 203 x 74 mm | 104307621 | bez DPH       | s DPH         |
|                   |           | <b>45,4 €</b> | <b>54,5 €</b> |



■ Držadlo lomené s mydlovničkou  
Bath grab bar angled with soap basket

|                    |           |               |               |
|--------------------|-----------|---------------|---------------|
| 440 x 220 x 130 mm | 104307631 | bez DPH       | s DPH         |
|                    |           | <b>56,8 €</b> | <b>68,1 €</b> |



■ Držadlo, guma  
Grab bar, rubber

|                  |           |               |               |
|------------------|-----------|---------------|---------------|
| 355 x 50 x 80 mm | 104507661 | bez DPH       | s DPH         |
|                  |           | <b>25,8 €</b> | <b>30,9 €</b> |



■ Držadlo, guma  
Grab bar, rubber

|                  |           |               |               |
|------------------|-----------|---------------|---------------|
| 455 x 50 x 85 mm | 104507675 | bez DPH       | s DPH         |
|                  |           | <b>27,2 €</b> | <b>32,6 €</b> |



■ Držadlo, guma  
Grab bar, rubber

|                  |           |               |               |
|------------------|-----------|---------------|---------------|
| 655 x 50 x 80 mm | 104507681 | bez DPH       | s DPH         |
|                  |           | <b>34,1 €</b> | <b>40,9 €</b> |



■ Držadlo, guma  
Grab bar, rubber

|                  |           |               |               |
|------------------|-----------|---------------|---------------|
| 855 x 50 x 80 mm | 104507691 | bez DPH       | s DPH         |
|                  |           | <b>49,9 €</b> | <b>59,9 €</b> |



■ Držadlo 90°, guma  
Grab bar 90°, rubber

|                   |           |             |               |               |
|-------------------|-----------|-------------|---------------|---------------|
| 420 x 420 x 80 mm | 104507731 | pravé/right | bez DPH       | s DPH         |
|                   | 104507721 | ľavé/left   | <b>51,1 €</b> | <b>61,4 €</b> |



■ Držadlo 135°, guma  
135° grab bar, black rubber

|                   |           |             |               |               |
|-------------------|-----------|-------------|---------------|---------------|
| 717 x 325 x 80 mm | 104507711 | pravé/right | bez DPH       | s DPH         |
|                   | 104507701 | ľavé/left   | <b>51,0 €</b> | <b>61,2 €</b> |

# WHITE

mosadz  
brass

biela  
white

sklo  
glass



- **Vešiačik**  
Single robe hook  
55 x 55 x 50 mm  
104106024  
bez DPH s DPH  
**10,3 € 12,3 €**



- **Vešiačik dvojité**  
Double robe hook  
55 x 55 x 50 mm  
104106034  
bez DPH s DPH  
**11,2 € 13,4 €**



- **Držiak toaletného papiera bez krytu**  
Paper holder without cover  
140 x 95 x 90 mm  
104112044  
bez DPH s DPH  
**16,9 € 20,2 €**



- **Držiak toaletného papiera s krytom**  
Paper holder with cover  
140 x 155 x 80 mm  
104112014  
bez DPH s DPH  
**27,2 € 32,6 €**



- **Držiak toaletného papiera**  
Paper holder  
175 x 55 x 70 mm  
104212034 pravý/right  
104212034L ľavý/left  
bez DPH s DPH  
**15,3 € 18,4 €**



- **Držiak toaletného papiera rezervný**  
Spare toilet paper holder  
55 x 165 x 65 mm  
104112034  
bez DPH s DPH  
**18,8 € 22,5 €**



- **Dvojité držiak toaletného papiera**  
Double paper holder  
385 x 55 x 85 mm  
104201074  
bez DPH s DPH  
**42,0 € 50,4 €**



- **WC kefa na zavesenie**  
Toilet brush holder, white brush  
95 x 370 x 140 mm  
104113014  
bez DPH s DPH  
**30,7 € 36,8 €**



- **WC kefa valcová malá, na polozenie**  
Freestanding toilet brush  
90 x 365 x 90 mm  
104913094  
bez DPH s DPH  
**30,6 € 36,8 €**



- **WC kefa na polozenie alebo zavesenie**  
Toilet brush holder, free standing or hanging  
95 x 385 x 90 mm  
102313064  
bez DPH s DPH  
**49,9 € 59,9 €**

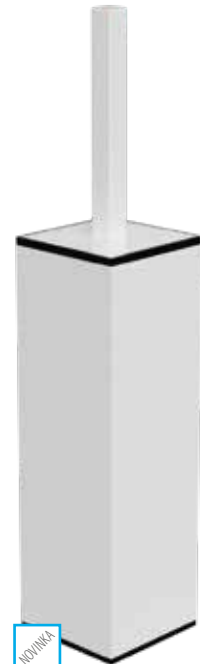

- **WC kefa na polozenie alebo zavesenie**  
Toilet brush holder, free standing or hanging  
80 x 400 x 80 mm  
102913094  
bez DPH s DPH  
**68,7 € 82,4 €**



■ **Kruh**  
Ring towel holder  
170 x 195 x 55 mm  
104104064  
bez DPH s DPH  
**18,9 € 22,7 €**



■ **Dávkočič tekutého mydla**  
Soap dispenser with glass  
80 x 180 x 105 mm, 230 ml  
104109014  
bez DPH s DPH  
**34,4 € 41,3 €**



■ **Dávkočič tekutého mydla, MINI**  
Soap dispenser with glass  
75 x 145 x 100 mm, 200 ml  
104109104  
bez DPH s DPH  
**33,8 € 40,5 €**



■ **Mydlovnička sklenená**  
Soap dish holder  
110 x 55 x 105 mm  
104108044  
bez DPH s DPH  
**20,0 € 24,0 €**



■ **Držiak na zubné kefy, sklo**  
Holder with glass  
70 x 95 x 105 mm  
104110014  
bez DPH s DPH  
**20,0 € 24,0 €**



■ **Odpadkový kôš „Soft Close“**  
Waste bin "Soft Close"  
205 x 280 x 205 mm, 5 l  
104315014  
bez DPH s DPH  
**16,8 € 20,1 €**



■ **Polička sklenená**  
Glass shelf  
600 x 55 x 130 mm  
104102044  
bez DPH s DPH  
**34,3 € 41,1 €**



■ **Polička na uteráky s hrazdou**  
Towel rack with rail  
550 x 120 x 265 mm  
104219074  
bez DPH s DPH  
**85,7 € 102,8 €**



■ **Závesné kozmetické zrkadlo s LED osvetlením**  
Cosmetic bath mirror with LED light  
255 x 200 x 400 mm, ø 200 mm  
112101144  
bez DPH s DPH  
**195,8 € 235,0 €**



NOVINKA



■ **Držiak uterákov**  
Towel holder  
104204024 505 x 55 x 65 mm bez DPH s DPH **30,3 € 36,4 €**  
104204044 655 x 55 x 65 mm bez DPH s DPH **32,0 € 38,4 €**



■ **Polička do sprchy**  
Corner soap basket  
262 x 35 x 142 mm  
102308264  
bez DPH s DPH  
**24,5 € 29,4 €**



■ **Závesné kozmetické zrkadlo**  
Cosmetic mirror  
230 x 310 x 450 mm, ø 190 mm  
112201514  
bez DPH s DPH  
**65,1 € 78,1 €**

# DARK

mosadz  
brass

čierna  
black

sklo  
glass



- **Vešiačik**  
Single robe hook  
55 x 55 x 50 mm  
104106020  
bez DPH      s DPH  
**10,3 €      12,3 €**



- **Vešiačik dvojité**  
Double robe hook  
55 x 55 x 50 mm  
104106030  
bez DPH      s DPH  
**12,4 €      14,9 €**



- **Vešiačik**  
Single robe hook  
55 x 55 x 65 mm  
104206020  
bez DPH      s DPH  
**14,8 €      17,8 €**



- **Vešiačik**  
Single robe hook  
55 x 55 x 65 mm  
104106060  
bez DPH      s DPH  
**8,3 €      9,9 €**



- **Držiak toaletného papiera s krytom**  
Paper holder with cover  
140 x 155 x 80 mm  
104112010  
bez DPH      s DPH  
**30,8 €      37,0 €**



- **Držiak toaletného papiera bez krytu**  
Paper holder without cover  
140 x 95 x 90 mm  
104112040  
bez DPH      s DPH  
**17,1 €      20,6 €**



- **Dvojité držiak toaletného papiera**  
Double paper holder  
385 x 55 x 85 mm  
104201070  
bez DPH      s DPH  
**20,0 €      24,0 €**



- **Držiak toaletného papiera rezervný**  
Spare toilet paper holder  
55 x 165 x 65 mm  
104112030  
bez DPH      s DPH  
**20,0 €      24,0 €**



- **WC kefa valcová**  
Toilet brush holder  
95 x 380 x 105 mm  
102313060  
bez DPH      s DPH  
**54,8 €      65,7 €**



- **WC kefa valcová, malá, na položení**  
Freestanding toilet brush  
90 x 385 x 90 mm  
104913090  
bez DPH      s DPH  
**32,7 €      39,3 €**



- **WC kefa, miska sklo**  
Toilet brush holder  
95 x 370 x 140 mm  
104113010  
bez DPH      s DPH  
**30,8 €      37,0 €**



- **Držiak toaletného papiera bez krytu**  
Toilet paper holder  
170 x 55 x 70 mm  
104212030      pravý/right  
104212030L      ľavý/left  
bez DPH      s DPH  
**23,4 €      28,10 €**



■ **Mydlovnička sklenená**  
Soap disk holder  
110 x 55 x 129 mm  
104108040  
bez DPH s DPH  
**24,0 € 28,8 €**



■ **Mydlovnička obdĺžniková, drôtená**  
Soap basket  
140 x 55 x 125 mm  
104108160  
bez DPH s DPH  
**23,8 € 28,5 €**



■ **Držiak na zubné kefky**  
Toothbrush holder  
105 x 54 x 89 mm  
104110030  
bez DPH s DPH  
**18,3 € 21,9 €**



■ **Držiak na zubné kefky, sklo**  
Holder with glass  
70 x 95 x 105 mm  
104110010  
bez DPH s DPH  
**23,9 € 28,7 €**



■ **Dávkovač tekutého mydla, sklo**  
Soap dispenser with glass  
80 x 190 x 133 mm, 230 ml  
104109010  
bez DPH s DPH  
**37,2 € 44,6 €**



■ **Dávkovač tekutého mydla, MINI**  
Soap dispenser, MINI glass  
75 x 145 x 100 mm, 200 ml  
104109100  
bez DPH s DPH  
**36,6 € 43,9 €**



■ **Mydlovnička trojuholníková**  
Corner soap basket  
262 x 35 x 142 mm  
102308260  
bez DPH s DPH  
**24,5 € 29,4 €**



■ **Držadlo**  
Grab bar  
470 x 65 x 90 mm  
104307770  
bez DPH s DPH  
**43,3 € 52,0 €**



■ **Kruh**  
Ring towel holder  
170 x 195 x 55 mm  
104104060  
bez DPH s DPH  
**18,9 € 22,7 €**



■ **Štvorháčik**  
Rail with 4 robe hooks  
270 x 25 x 40 mm  
104606100  
bez DPH s DPH  
**20,5 € 24,6 €**



■ **Držiak uterákov na sklenené dvere**  
Towel rack for glass door  
104204310 470 x 20 x 133 mm bez DPH s DPH **47,0 € 56,4 €**  
104204320 620 x 20 x 133 mm bez DPH s DPH **48,0 € 57,6 €**



■ **Kruh**  
Ring towel holder  
160 x 175 x 65 mm  
104204060  
bez DPH s DPH  
**23,9 € 28,7 €**



■ **Polička na uteráky**  
Towel rack  
655 x 55 x 215 mm  
104205080  
bez DPH s DPH  
**74,7 € 89,6 €**

# DARK

mosadz  
brass

čierna  
black

sklo  
glass



## ■ Polička na uteráky s hrazdou

Towel rack with rail

550 x 120 x 265 mm

104219070

bez DPH s DPH

85,7 € 102,8 €



## ■ Držiak uterákov

Towel holder

104204010 355 x 55 x 65 mm

104204020 505 x 55 x 65 mm

104204040 655 x 55 x 65 mm

bez DPH s DPH

30,3 € 36,4 €

30,8 € 37,0 €

24,1 € 28,9 €



## ■ Dvojitý držiak uterákov

Double towel holder

655 x 55 x 110 mm

104204050

bez DPH s DPH

49,2 € 59,1 €



## ■ Polička sklenená

Glass shelf

600 x 55 x 130 mm

104102040

bez DPH s DPH

30,8 € 37,0 €

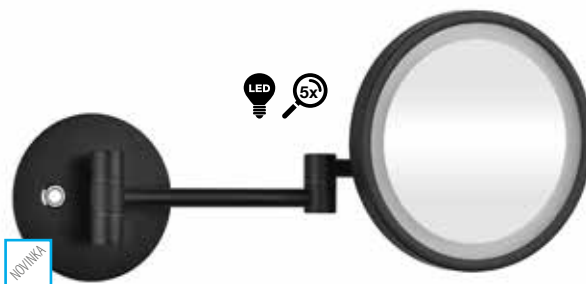

## ■ Závesné kozmetické zrkadlo s LED osvetlením

Cosmetic bath mirror with LED light

255 x 200 x 400 mm, ø 200 mm

112101140

bez DPH s DPH

195,8 € 235,0 €



## ■ Závesné kozmetické zrkadlo s LED osvetlením

Cosmetic bath mirror with LED light

225 x 200 x 365 mm, ø 200 mm, 5,6 W

116101770

bez DPH s DPH

220,0 € 264,0 €



## ■ Kozmetické zrkadlo

Cosmetic mirror

230 x 310 x 450 mm, ø 190 mm

112201510

bez DPH s DPH

98,0 € 117,6 €



## ■ Odpadkový kôš „Soft Close“

Waste bin "Soft Close"

200 x 280 x 205 mm, 5 l

104315010

bez DPH s DPH

16,8 € 20,1 €



## ■ Zásobník na papierové vreckovky, nerez

Paper tissue dispenser

250 x 130 x 70 mm

102303020

bez DPH s DPH

35,0 € 42,0 €



## ■ Zásobník hygienických sáčkov, mat, plast

Hygienic bag dispenser

138 x 99 x 27 mm

101403030

bez DPH s DPH

7,9 € 9,4 €

# NERO

mosadz  
brass

čierna  
black

sklo  
glass

**BEMETA®**



- **Vešiačik**  
Single robe hook  
17 x 38 x 30 mm  
135006010  
bez DPH      s DPH  
**8,6 €      10,3 €**



- **Vešiačik**  
Single robe hook  
25 x 67 x 37 mm  
135106020  
bez DPH      s DPH  
**8,0 €      9,6 €**



- **Vešiačik dvojité**  
Double robe hook  
80 x 28 x 39 mm  
135006030  
bez DPH      s DPH  
**12,1 €      14,5 €**



- **Vešiačik dvojité**  
Double robe hook  
37 x 26 x 30 mm  
135006230  
bez DPH      s DPH  
**9,6 €      11,6 €**



- **Vešiačik dvojité**  
Double robe hook  
83 x 46 x 33 mm  
135106030  
bez DPH      s DPH  
**12,0 €      14,4 €**



- **Štvorháčik**  
Rail with 4 robe hooks  
205 x 46 x 33 mm  
135105210  
bez DPH      s DPH  
**23,0 €      27,6 €**



- **Držiak toaletného papiera**  
Paper holder  
179 x 28 x 59 mm  
135012020  
bez DPH      s DPH  
**23,0 €      27,6 €**



- **Držiak toaletného papiera s krytom**  
Paper holder with cover  
130 x 95 x 90 mm  
135012010  
bez DPH      s DPH  
**34,3 €      41,1 €**



- **Držiak toaletného papiera bez krytu**  
Paper holder without cover  
131 x 90 x 75 mm  
135012220  
bez DPH      s DPH  
**22,9 €      27,5 €**



- **WC kefa, miska sklo**  
Toilet brush holder, white brush  
93 x 385 x 127 mm  
135013010  
bez DPH      s DPH  
**34,3 €      41,1 €**



- **WC kefa hranatá na polozenie alebo zavesenie**  
Toilet brush holder, wall mounted/free standing  
80 x 400 x 80 mm  
135913090  
bez DPH      s DPH  
**68,7 €      82,4 €**

# NERO

mosadz  
brass

čierna  
black

sklo  
glass



■ Mydlovnička sklenená  
Soap dish holder  
103 x 42 x 117 mm  
135008020  
bez DPH s DPH  
**24,0 € 28,8 €**



■ Držiak na zubné kefky, sklo  
Holder with glass  
64 x 100 x 97 mm  
135011010  
bez DPH s DPH  
**23,9 € 28,7 €**



■ Dávkovač tekutého mydla, sklenený  
Soap dispenser with glass  
65 x 150 x 120 mm, 250 ml  
135009040  
bez DPH s DPH  
**40,8 € 49,0 €**



■ Kruh  
Ring towel holder  
220 x 20 x 110 mm  
135004060  
bez DPH s DPH  
**29,8 € 35,7 €**



■ Držiak uterákov  
Towel holder  
600 x 20 x 59 mm  
135004040  
bez DPH s DPH  
**43,3 € 52,0 €**



■ Dvojitý držiak uterákov  
Double towel holder  
500 x 20 x 132 mm  
135004080  
bez DPH s DPH  
**67,7 € 81,2 €**

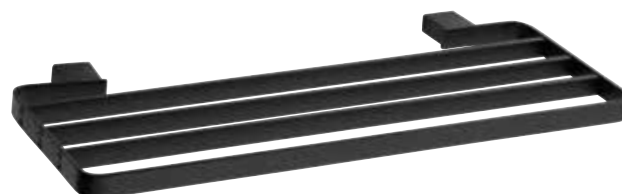

■ Polička na uteráky  
Towel rack  
500 x 20 x 205 mm  
135002180  
bez DPH s DPH  
**92,6 € 111,2 €**



■ Držadlo  
Bath grab bar  
320 x 40 x 60 mm  
135007670  
bez DPH s DPH  
**43,3 € 52,0 €**



■ Polička sklenená  
Glass shelf  
600 x 19 x 118 mm  
135002240  
bez DPH s DPH  
**30,7 € 36,8 €**





- **Vešiak valcový**  
Single robe hook  
55 x 55 x 55 mm  
104106065  
bez DPH 8,5 €    s DPH 10,2 €



- **Vešiačik**  
Single robe hook  
55 x 55 x 50 mm  
104106025  
bez DPH 10,2 €    s DPH 24,7 €



- **Vešiačik dvojité**  
Double robe hook  
55 x 55 x 50 mm  
104106035  
bez DPH 11,3 €    s DPH 13,5 €



- **Vešiačik**  
Single robe hook  
104506095 ø 16 x 30 mm  
bez DPH 4,8 €    s DPH 5,7 €  
104106165 ø 16 x 55 mm  
5,4 €    6,5 €



- **Trojháčik otočný**  
Triple hook  
55 x 190 x 110 mm  
104206075  
bez DPH 32,0 €    s DPH 38,4 €



- **Držiak toaletného papiera s krytom**  
Paper holder with cover  
135 x 155 x 90 mm  
104112015  
bez DPH 26,0 €    s DPH 31,2 €

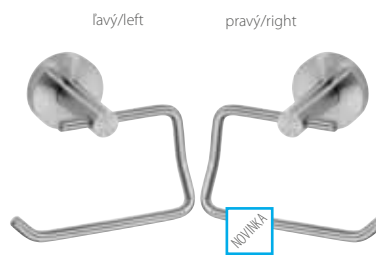

- **Držiak toaletného papiera bez krytu**  
Paper holder without cover  
145 x 120 x 98 mm  
104112045R pravý/right  
104112045 ľavý/left  
bez DPH 17,8 €    s DPH 21,4 €



- **Držiak toaletného papiera**  
Paper holder without cover  
175 x 55 x 70 mm  
104212035  
bez DPH 24,1 €    s DPH 28,9 €



- **Držiak toaletného papiera, rezervní**  
Spare toilet paper holder  
55 x 165 x 65 mm  
104112035  
bez DPH 18,8 €    s DPH 22,6 €



- **Zásobník na toaletný papier voľne stojaci, mat/lesk**  
Free standing toilet paper holder,  
matt/polished  
120 x 352 x 120 mm  
146203165  
bez DPH 17,8 €    s DPH 21,4 €



- **Dvojité držiak toaletného papiera bez krytu**  
Double paper holder  
320 x 30 x 90 mm  
146212245  
bez DPH 37,8 €    s DPH 45,4 €



- **WC kefa na polozenie, miska sklo**  
Toilet brush holder, free standing  
110 x 400 x 130 mm  
104113105\*  
104113109\*\*  
bez DPH 22,7 €    s DPH 27,2 €



- **WC kefa na zavesenie, miska sklo**  
Wall mounted toilet brush with glass  
115 x 360 x 130 mm  
104113015\*  
104113019\*\*  
bez DPH 26,1 €    s DPH 31,3 €



- **WC kefa valcová, malá**  
Wall mounted toilet brush  
90 x 380 x 115 mm  
102313075\*  
102313079\*\*  
bez DPH 45,4 €    s DPH 54,5 €



- **WC kefa valcová na polozenie**  
Toilet brush holder, free standing  
95 x 380 x 95 mm  
102313055\*  
102313059\*\*  
bez DPH 37,4 €    s DPH 44,9 €



- **WC kefa valcová na polozenie alebo zavesenie**  
Toilet brush holder, free standing or hanging  
95 x 390 x 105 mm  
102313065\*  
102313069\*\*  
bez DPH 52,3 €    s DPH 62,7 €

# NEO

nerez  
stainless

sklo  
glass

mat  
matt



- **Kruh**  
Ring towel holder  
160 x 190 x 50 mm  
104104065  
bez DPH s DPH  
**21,6 € 26,0 €**



- **Dávkovač tekutého mydla, MINI**  
Soap dispenser, MINI glass  
75 x 145 x 100 mm, 200 ml  
104109115  
bez DPH s DPH  
**26,1 € 31,3 €**



- **Dávkovač tekutého mydla, sklo**  
Glass soap dispenser  
80 x 190 x 133 mm, 230 ml  
104109016  
bez DPH s DPH  
**35,7 € 42,9 €**



- **Dávkovač tekutého mydla, nerez**  
Soap dispenser  
55 x 175 x 85 mm, 150 ml  
104109015  
bez DPH s DPH  
**43,0 € 51,6 €**



- **Dávkovač tekutého mydla, JUMBO**  
Soap dispenser JUMBO  
70 x 230 x 110 mm, 550 ml  
104109035  
bez DPH s DPH  
**71,5 € 85,7 €**



- **Dávkovač tekutého mydla**  
Soap dispenser  
100 x 320 x 110 mm, 1 100 ml  
123209013  
bez DPH s DPH  
**64,6 € 77,5 €**



- **Mydlovnička sklenená**  
Glass soap dish  
110 x 55 x 125 mm  
104108045  
bez DPH s DPH  
**18,3 € 21,9 €**



- **Mydlovnička obdĺžniková, kovová**  
Soap dish rectangular  
125 x 55 x 115 mm  
104208085  
bez DPH s DPH  
**20,3 € 24,3 €**



- **Polička kovová**  
Soap dish  
270 x 40 x 110 mm  
146102275  
bez DPH s DPH  
**49,2 € 59,1 €**



- **Polička do sprchy, drôtená**  
Soap basket  
230 x 30 x 120 mm  
104308072  
bez DPH s DPH  
**20,6 € 24,7 €**



- **Polička do sprchy, drôtená, rohová**  
Corner soap basket  
230 x 30 x 130 mm  
104308172  
bez DPH s DPH  
**20,3 € 24,3 €**



- **Držiak na zubné kefkы, sklo**  
Holder with glass  
70 x 95 x 105 mm  
104110015  
bez DPH s DPH  
**17,2 € 20,6 €**



- **Dvojitý držiak na zubné kefkы**  
Double glass holder  
175 x 118 x 90 mm  
104210025  
bez DPH s DPH  
**29,6 € 35,5 €**



- **Dvojitý držiak uterákov, otočný**  
Double swing arm towel holder  
55 x 165 x 440 mm  
104204105  
bez DPH s DPH  
**42,6 € 51,1 €**



- **Polička na uteráky, s hrazdou**  
Towel rack  
655 x 110 x 215 mm  
104205075  
bez DPH s DPH  
**78,4 € 94,1 €**

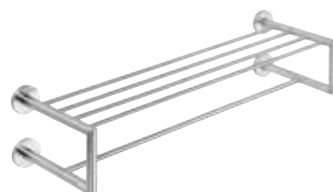

- **Polička na uteráky, dvojitá**  
Towel rack  
655 x 160 x 225 mm  
104205105  
bez DPH s DPH  
**87,8 € 105,4 €**



- **Držiak uterákov**  
Towel holder  
355 x 55 x 65 mm  
104204015  
bez DPH 26,1 € s DPH 31,3 €  
505 x 55 x 65 mm  
104204125  
bez DPH 29,9 € s DPH 35,9 €  
655 x 55 x 65 mm  
104204045  
bez DPH 34,4 € s DPH 41,2 €



- **Dvojitý držiak uterákov**  
Double towel holder  
655 x 55 x 125 mm  
104204055  
bez DPH 41,6 € s DPH 50,0 €

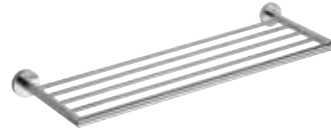

- **Polička na uteráky**  
Towel rack  
55 x 165 x 440 mm  
104205085  
bez DPH 69,5 € s DPH 83,4 €



- **Držadlo pevné**  
Bath grab bar  
355 x 55 x 75 mm  
102307015  
bez DPH 29,9 € s DPH 35,8 €



- **Vešiacik na dvere**  
Over door hook  
20 x 70 x 40 mm  
104106153  
bez DPH 14,7 € s DPH 17,7 €



- **Štvorháčik**  
Rail with 4 robe hooks  
270 x 28 x 40 mm  
104606105  
bez DPH 20,5 € s DPH 24,6 €



- **Šestháčik**  
Rail with 6 robe hooks  
410 x 28 x 40 mm  
104606115  
bez DPH 26,1 € s DPH 31,4 €



- **Polička sklenená**  
Glass shelf  
600 x 55 x 130 mm  
104102045  
bez DPH 28,4 € s DPH 34,1 €



- **Polička sklenená, rohová**  
Glass shelf, corner model  
244 x 55 x 244 mm  
104102015  
bez DPH 30,3 € s DPH 36,3 €



- **Závesné kozmetické zrkadlo**  
Cosmetic mirror matt  
184 x 200 x 412 mm, ø 133 mm  
106301705  
bez DPH 60,8 € s DPH 73,0 €



- **Zásobník hygienických sáčků**  
Hygienic bag dispenser  
95 x 145 x 30 mm  
101403035  
bez DPH 28,5 € s DPH 34,2 €



- **Zásobník hygienických vreciek**  
Hygienic bag dispenser  
250 x 130 x 75 mm  
102303025  
bez DPH 45,0 € s DPH 54,0 €

# BETA

mosadz  
brass

chróm  
chrome

lesk  
shiny

sklo  
glass



■ **Vešiačik**  
Single robe hook  
55 x 55 x 50 mm  
132106022  
bez DPH 11,3 € s DPH 13,5 €



■ **Vešiačik dvojitý**  
Double robe hook  
55 x 55 x 50 mm  
132106032  
bez DPH 13,0 € s DPH 15,6 €



■ **Trojháčik otočný**  
Swing arm triple hook  
55 x 190 x 135 mm  
132206072  
bez DPH 29,8 € s DPH 35,7 €



■ **Dvojháčik vysoký**  
Double hook  
55 x 120 x 90 mm  
132405222  
bez DPH 23,0 € s DPH 27,6 €



■ **Dvojháčik**  
Double hook  
120 x 55 x 50 mm  
132405202  
bez DPH 20,6 € s DPH 24,7 €



■ **Trojháčik**  
Triple hook  
185 x 55 x 50 mm  
132405232  
bez DPH 28,1 € s DPH 33,8 €



■ **Štvorháčik**  
4 robe hooks  
250 x 55 x 50 mm  
132405212  
bez DPH 34,4 € s DPH 41,2 €



■ **Vešiačik jednoduchý**  
Single robe hook  
19 x 35 x 38 mm  
132106132  
bez DPH 8,8 € s DPH 10,5 €



■ **Vešiačik hranatý**  
Single robe hook  
55 x 55 x 50 mm  
132306172  
bez DPH 8,2 € s DPH 9,8 €



■ **Držiak toaletného papiera s krytom**  
Paper holder with cover  
138 x 150 x 80 mm  
132112012  
bez DPH 24,7 € s DPH 29,7 €



■ **Držiak toaletného papiera bez krytu**  
Paper holder without cover  
135 x 100 x 90 mm  
132112042  
bez DPH 20,3 € s DPH 24,3 €



■ **Držiak toaletného papiera bez krytu**  
Paper holder without cover  
180 x 55 x 70 mm  
132212032 pravý/right  
132212032L ľavý/left  
bez DPH 23,0 € s DPH 27,6 €



■ **Držiak toaletného papiera rezervný**  
Spare toilet paper holder  
55 x 165 x 65 mm  
132112032  
bez DPH 16,5 € s DPH 19,8 €



■ **Kruh**  
Ring towel holder  
168 x 188 x 50 mm  
132104062  
bez DPH 22,0 € s DPH 26,4 €



■ **Hrazda s 5 vešiakmi**  
Rail with 5 robe hooks  
415 x 55 x 70 mm  
132105112  
bez DPH 27,1 € s DPH 32,6 €



■ WC kefa na zavesenie,  
miska sklo  
Wall mounted toilet brush holder  
with glass dish  
95 x 360 x 140 mm  
132113012 biela kefa/white brush  
132113017 čierna kefa/black brush  
bez DPH s DPH  
**28,5 € 34,2 €**



■ WC kefa hranatá na polozenie  
alebo zavesenie  
Toilet brush holder, free standing  
or hanging  
85 x 440 x 85 mm  
118113092  
bez DPH s DPH  
**84,0 € 100,8 €**



■ WC kefa hranatá na polozenie  
alebo zavesenie  
Toilet brush holder, free standing  
or hanging  
80 x 360 x 80 mm  
118213092  
bez DPH s DPH  
**84,0 € 100,8 €**



■ WC kefa hranatá na polozenie  
alebo zavesenie  
Toilet brush holder, free standing  
or hanging  
80 x 400 x 80 mm  
135913091  
bez DPH s DPH  
**56,7 € 68,1 €**



■ Stojan s držiakom na toaletný  
papier a WC kefov  
Free standing toilet paper and brush  
holder  
150 x 710 x 255 mm  
132836012  
bez DPH s DPH  
**130,5 € 156,6 €**



■ Mydlovnička sklenená  
Soap dish holder  
110 x 55 x 125 mm  
132108042  
bez DPH s DPH  
**17,2 € 20,6 €**



■ Mydlovnička obdĺžniková  
Soap dish rectangular  
129 x 55 x 110 mm  
132208082  
bez DPH s DPH  
**18,9 € 22,7 €**



■ Mydlovnička obdĺžniková,  
drôtená  
Soap dish basket  
140 x 52 x 125 mm  
132108162  
bez DPH s DPH  
**20,6 € 24,8 €**



■ Mydlovnička magnetická  
Magnetic soap holder  
55 x 55 x 70 mm  
132108202  
bez DPH s DPH  
**18,2 € 21,8 €**



■ Dávkač tekutého mydla  
Soap dispenser  
80 x 180 x 133 mm, 250 ml  
132109017  
bez DPH s DPH  
**37,5 € 45,0 €**



■ Dávkač tekutého mydla  
s magnetickou mydlovničkou  
Soap dispenser with magnetic soap  
holder, mini glass  
75 x 160 x 100 mm, 200 ml  
132109182  
bez DPH s DPH  
**49,2 € 59,1 €**

# BETA

mosadz  
brass

chróm  
chrome

lesk  
shiny

sklo  
glass



- **Dávkovač tekutého mydla, MINI**  
Soap dispenser MINI glass  
70 x 145 x 100 mm, 200 ml  
132109102  
bez DPH      s DPH  
**30,3 €      36,3 €**



- **Držiak na zubné kefkы, sklo**  
Glass with holder  
70 x 95 x 105 mm  
132110012  
bez DPH      s DPH  
**17,2 €      20,6 €**



- **Dvojitý držiak na zubné kefkы, sklo**  
Double glass holder  
160 x 95 x 90 mm  
132110022  
bez DPH      s DPH  
**28,9 €      34,6 €**



- **Dvojitý držiak na zubné kefkы, sklo**  
Toothbrush holder with glasses  
190 x 95 x 125 mm  
132110042  
bez DPH      s DPH  
**41,2 €      49,4 €**



- **Držiak na zubné kefkы**  
Toothbrush holder  
105 x 55 x 85 mm  
132110032  
bez DPH      s DPH  
**15,1 €      18,1 €**



- **Polička sklenená**  
Glass shelf  
300 x 55 x 130 mm  
132122042  
bez DPH      s DPH  
**27,1 €      32,6 €**



- **Polička sklenená**  
Glass shelf  
600 x 55 x 130 mm  
132102042  
bez DPH      s DPH  
**30,0 €      36,0 €**



- **Stojan s držiakom na uteráky, dvojitý**  
Free standing double towel holder  
150 x 800 x 400 mm  
132836022  
bez DPH      s DPH  
**127,3 €      152,8 €**



- **Polička sklenená, rohová**  
Glass shelf, corner model  
255 x 55 x 255 mm  
132102012  
bez DPH      s DPH  
**30,3 €      36,3 €**



- **Polička sklenená, s výklopnou hrazdou**  
Glass shelf with tiltable rail  
600 x 55 x 130 mm  
132102212  
bez DPH      s DPH  
**44,6 €      53,6 €**



- **Držiak uterákov**  
Towel holder  
132104012 355 x 55 x 65 mm      bez DPH      s DPH      **24,0 €      28,8 €**  
132104022 505 x 55 x 65 mm      **26,2 €      31,4 €**  
132104042 655 x 55 x 65 mm      **28,2 €      33,8 €**



- **Dvojitý držiak uterákov**  
Double towel holder  
655 x 55 x 110 mm  
132104052  
bez DPH      s DPH  
**34,4 €      41,2 €**



- **Držiak uterákov**  
Towel holder  
132204012 355 x 55 x 65 mm      bez DPH      s DPH      **24,0 €      28,8 €**  
132204022 505 x 55 x 65 mm      **28,4 €      34,1 €**  
132204042 655 x 55 x 65 mm      **32,0 €      38,4 €**



- **Dvojitý držiak uterákov**  
Double towel holder  
655 x 55 x 120 mm  
132204052  
bez DPH      s DPH  
**40,1 €      48,1 €**

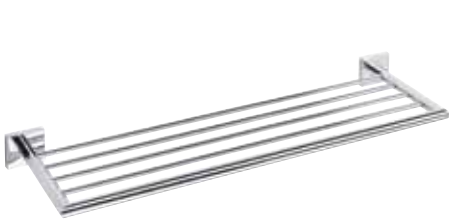

■ **Polička na uteráky**  
Towel rack  
655 x 55 x 215 mm  
132205082  
bez DPH s DPH  
**59,1 € 70,9 €**



■ **Polička na uteráky s hrazdou**  
Towel rack  
655 x 106 x 215 mm  
132205072  
bez DPH s DPH  
**67,8 € 81,3 €**

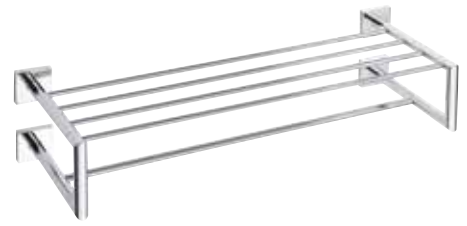

■ **Polička na uteráky dvojitá s hrazdou**  
Towel rack  
655 x 160 x 225 mm  
132205102  
bez DPH s DPH  
**89,4 € 107,3 €**



■ **Držadlo pevné**  
Bath grab bar  
355 x 55 x 80 mm  
132307611  
bez DPH s DPH  
**52,0 € 62,4 €**



■ **Dvojitý držiak uterákov, otočný na jednej rúčke**  
Double swing arm towel holder  
55 x 40 x 420 mm  
132204191  
bez DPH s DPH  
**32,5 € 39 €**



■ **Dvojitý držiak uterákov, otočný**  
Double swing arm towel holder  
55 x 165 x 450 mm  
132204102  
bez DPH s DPH  
**44,7 € 53,7 €**



■ **Sprchová tyč s jazdcom**  
Shower rail  
90 x 900 x 110 mm  
132114122  
bez DPH s DPH  
**66,3 € 79,5 €**



■ **Závesné kozmetické zrkadlo na tyči**  
Cosmetic mirror  
200 x 550 x 140 mm  
132201172  
bez DPH s DPH  
**131,8 € 158,2 €**



■ **Držiak fénu**  
Hair dryer holder  
80 x 55 x 100 mm  
132117012  
bez DPH s DPH  
**19,2 € 23,1 €**



■ **Držiak fénu špirálový**  
Hair dryer holder, spiral  
100 x 185 x 125 mm  
132117022  
bez DPH s DPH  
**20,6 € 24,7 €**



■ **Držiak na poličku, pár**  
Glass shelf holder – without glass, pair  
55 x 55 x 40 mm ≠ 8 mm  
132102112  
bez DPH s DPH  
**20,6 € 24,7 €**

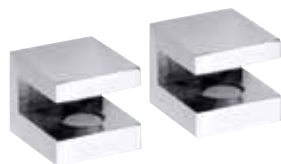

■ **Držiak na poličku, pár**  
Glass shelf holder – without glass, pair  
20 x 20 x 25 mm ≠ 6 až 8 mm  
102202112  
bez DPH s DPH  
**11,0 € 13,1 €**



■ **Držiak na poličku, pár**  
Glass shelf holder – without glass, pair  
47 x 15 x 45 mm ≠ 6 až 8 mm  
102102112  
bez DPH s DPH  
**11,0 € 13,1 €**



■ **Redukcia úchytky pre lepenie na sklo\*\*\***  
Back plate for gluing accessories on glass\*\*\*  
55 x 55 x 14 mm  
131567155  
bez DPH s DPH  
**5,5 € 6,6 €**

# TASI

mosadz  
brass

chróm  
chrome

lesk  
polished

sklo  
glass



- **Vešiačik**  
Single robe hook  
50 x 50 x 57 mm  
154106062  
bez DPH      s DPH  
**8,5 €      10,2 €**



- **Vešiačik dvojité**  
Double hook  
80 x 50 x 60 mm  
154106032  
bez DPH      s DPH  
**12,4 €      14,9 €**



- **Držiak na toaletný papier s krytom**  
Paper holder with cover  
137 x 144 x 78 mm  
154112012  
bez DPH      s DPH  
**26,1 €      31,3 €**



- **Držiak na toaletný papier bez krytu**  
Paper holder without cover  
137 x 130 x 66 mm  
154112022  
bez DPH      s DPH  
**18,5 €      22,2 €**



- **Mydlovnička sklenená**  
Soap disk holder  
110 x 52 x 129 mm  
154108022  
bez DPH      s DPH  
**18,5 €      22,2 €**



- **Dávkač tekutého mydla**  
Soap dispenser with glass  
82 x 192 x 130 mm, 230 ml  
154109042  
bez DPH      s DPH  
**30,0 €      36,0 €**



- **Držiak na zubné kefky, sklo**  
Holder with glass  
67 x 96 x 107 mm  
154110012  
bez DPH      s DPH  
**18,5 €      22,2 €**



- **Kruh**  
Ring towel holder  
205 x 146 x 60 mm  
154104062  
bez DPH      s DPH  
**22,0 €      26,4 €**



- **Držiak uterákov**  
Towel holder  
656 x 50 x 87 mm  
154104042  
bez DPH      s DPH  
**26,5 €      31,7 €**



- **WC kefa, miska sklo**  
Toilet brush holder  
110 x 370 x 145 mm  
154113012  
bez DPH      s DPH  
**26,5 €      31,7 €**



- **Polička sklenená**  
Glass shelf  
600 x 50 x 132 mm  
154102242  
bez DPH      s DPH  
**26,5 €      31,7 €**



- **Polička na uteráky s hrazdou**  
Towel rack with rail 600 mm  
656 x 105 x 216 mm  
154105262  
bez DPH      s DPH  
**61,7 €      74,1 €**



# SOLO

mosadz  
brass

chróm  
chrome

lesk  
polished

sklo  
glass

**BEMETA®**



- **Vešičik**  
Single robe hook  
25 x 67 x 32 mm  
139106022  
bez DPH      s DPH  
**6,7 €      8,1 €**



- **Vešičik dvojité**  
Double robe hook  
83 x 46 x 33 mm  
139106032  
bez DPH      s DPH  
**9,5 €      11,4 €**



- **Štvorvešič**  
4 robe hook  
205 x 46 x 33 mm  
139105212  
bez DPH      s DPH  
**18,9 €      22,7 €**



- **Držiak toaletného papiera s krytom**  
Paper holder with cover  
128 x 64 x 130 mm  
139112012  
bez DPH      s DPH  
**27,0 €      32,4 €**



- **Držiak toaletného papiera bez krytu**  
Paper holder without cover  
129 x 25 x 82 mm  
139112022  
bez DPH      s DPH  
**17,1 €      20,5 €**



- **WC kefa, miska sklo**  
Wall mounted toilet brush with glass  
83 x 390 x 93 mm  
139113142  
bez DPH      s DPH  
**25,8 €      31,0 €**



- **Mydlovnička sklenená**  
Soap disk holder  
104 x 45 x 110 mm  
139108032  
bez DPH      s DPH  
**16,9 €      20,2 €**



- **Držiak na zubné kefy, sklo**  
Holder with glass  
75 x 101 x 91 mm  
139110012  
bez DPH      s DPH  
**16,9 €      20,2 €**



- **Dávkoč tekutého mydla, sklo**  
Soap dispenser with glass  
75 x 170 x 91 mm, 200 ml  
139309312  
bez DPH      s DPH  
**47,9 €      57,4 €**



- **Dávkoč tekutého mydla, sklo**  
Soap dispenser with glass  
75 x 170 x 91 mm  
139109042  
bez DPH      s DPH  
**26,3 €      31,6 €**



- **Kruh**  
Ring towel holder  
200 x 25 x 82 mm  
139104062  
bez DPH      s DPH  
**21,0 €      25,2 €**



- **Držiak uterákov**  
Towel holder  
600 x 25 x 80 mm  
139104282  
bez DPH      s DPH  
**52,6 €      63,1 €**



- **Dvojité držiak uterákov**  
Towel rack  
600 x 108 x 255 mm  
139105262  
bez DPH      s DPH  
**67,2 €      80,6 €**



- **Dvojité držiak uterákov otočný**  
Double towel holder  
600 x 25 x 130 mm  
139104052  
bez DPH      s DPH  
**31,7 €      38,0 €**



- **Polička na uteráky s hrazdou**  
Towel holder  
398,5 x 47,2 x 83 mm  
139104102  
bez DPH      s DPH  
**146,4 €      175,6 €**



- **Polička sklenená**  
Glass shelf  
500 x 25 x 110 mm  
139102312  
bez DPH      s DPH  
**75,1 €      90,1 €**

mosadz  
brass

chróm  
chrome

lesk  
shiny

sklo  
glass



■ **Vešiacik**  
Single robe hook  
17 x 38 x 30 mm  
135006012  
bez DPH      s DPH  
**6,0 €      7,2 €**



■ **Vešiacik dvojity**  
Double robe hook  
37 x 26 x 30 mm  
135006232  
bez DPH      s DPH  
**8,2 €      9,8 €**



■ **Vešiacik**  
Single robe hook  
25 x 70 x 48 mm  
102306172  
bez DPH      s DPH  
**8,2 €      9,8 €**



■ **Vešiacik dvojity**  
Double robe hook  
80 x 28 x 39 mm  
135006032  
bez DPH      s DPH  
**12,0 €      14,4 €**

pravý/right



ľavý/left



■ **Držiak toaletného papiera bez krytu**  
Paper holder without cover  
179 x 28 x 59 mm  
135012022 pravý/right  
135012022L ľavý/left  
bez DPH      s DPH  
**19,5 €      23,4 €**



■ **Držiak toaletného papiera bez krytu**  
Paper holder without cover  
131 x 90 x 75 mm  
135012222  
bez DPH      s DPH  
**20,6 €      24,7 €**



■ **Držiak toaletného papiera s krytom**  
Paper holder with cover  
130 x 95 x 90 mm  
135012012  
bez DPH      s DPH  
**27,5 €      33,9 €**

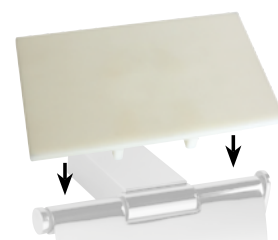

■ **Polička na mobilný telefón**  
Mobile phone shelf for toilet paperholder  
132 x 27 x 99 mm  
131567032  
bez DPH      s DPH  
**6,2 €      7,4 €**



■ **WC kefa na zavesenie, miska sklo**  
Wall mounted toilet brush holder  
93 x 385 x 127 mm  
135013012  
bez DPH      s DPH  
**34,4 €      41,2 €**



■ **WC kefa na položenie/zavesenie**  
Toilet brush wall mounted/free standing  
85 x 440 x 85 mm  
118113092  
bez DPH      s DPH  
**84,0 €      100,8 €**



■ **WC kefa na položenie/zavesenie**  
Toilet brush wall mounted/free standing  
80 x 360 x 80 mm  
118213092  
bez DPH      s DPH  
**84,0 €      100,8 €**



■ **WC kefa na položenie/zavesenie**  
Toilet brush wall mounted/free standing  
80 x 400 x 80 mm  
135913091  
bez DPH      s DPH  
**56,7 €      68,1 €**

NOVINKA



- **Držiak toaletného papiera rezervný, na 2 role**  
Spare paper holder, extended  
20 x 300 x 59 mm  
135012032  
bez DPH **32,0 €** s DPH **38,4 €**



- **Kruh**  
Ring towel holder  
220 x 20 x 100 mm  
135004062  
bez DPH **34,4 €** s DPH **41,2 €**



- **Dvojitý držiak uterákov otočný**  
Double swing arm towel holder  
46 x 32 x 445 mm  
135004102  
bez DPH **57,1 €** s DPH **68,6 €**



- **Držiak uterákov**  
Towel holder  
135004022 450 x 20 x 59 mm  
135004042 600 x 20 x 59 mm

bez DPH **44,7 €** s DPH **53,6 €**  
bez DPH **49,9 €** s DPH **59,8 €**



- **Dvojitý držiak uterákov**  
Double towel holder  
500 x 20 x 132 mm  
135004082  
bez DPH **76,7 €** s DPH **92,0 €**



- **Polička na uteráky**  
Towel rack  
500 x 20 x 205 mm  
135002182  
bez DPH **96,0 €** s DPH **115,2 €**

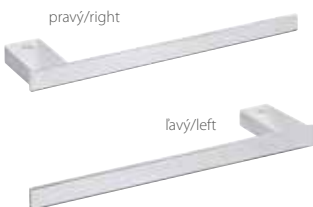

- **Držiak uterákov**  
Towel holder  
297 x 20 x 59 mm  
135004043 pravý/right  
135004044 ľavý/left  
bez DPH **32,0 €** s DPH **38,4 €**



- **Polička sklenená**  
Glass shelf  
135002242 600 x 19 x 118 mm  
135002352 500 x 19 x 118 mm

bez DPH **24,7 €** s DPH **29,7 €**  
bez DPH **27,0 €** s DPH **32,4 €**



- **Držadlo**  
Bath grab bar  
320 x 40 x 60 mm  
135007072  
bez DPH **61,8 €** s DPH **74,2 €**



- **Držiak na zubné kefky, sklo**  
Holder with glass  
63 x 100 x 97 mm  
135011012  
bez DPH **23,0 €** s DPH **27,6 €**



- **Mydlovnička sklenená**  
Glass soap dish  
103 x 42 x 117 mm  
135008022  
bez DPH **23,0 €** s DPH **27,6 €**



- **Dávkovač tekutého mydla, sklo**  
Soap dispenser with glass  
65 x 150 x 120 mm, 250 ml  
135009042  
bez DPH **34,4 €** s DPH **41,2 €**

# PLAZA

mosadz  
brass

chróm  
chrome

lesk  
shiny

sklo  
glass

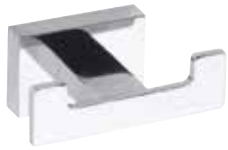

## ■ Vešiacik dvojitý

Double robe hook

78 x 35 x 50 mm

118106032

bez DPH s DPH

20,6 € 24,7 €



118112012

## ■ Držiak toaletného papiera, s krytom

Paper holder with cover

125 x 125 x 65 mm

118112012

118112012H hranatý úchyt/square handle

bez DPH s DPH

27,2 € 32,6 €



118112012H



## ■ Držiak toaletného papiera, bez krytu

Paper holder without cover

190 x 35 x 70 mm

118112022

bez DPH s DPH

25,4 € 30,5 €



## ■ WC kefa na zavesenie, miska sklo

Wall mounted toilet brush with glass dish

115 x 360 x 150 mm

118113012

bez DPH s DPH

45,4 € 54,5 €



## ■ WC kefa na polozenie alebo zavesenie

Toilet brush holder, free standing or hanging

85 x 440 x 85 mm

118113092

bez DPH s DPH

84,0 € 100,8 €



## ■ WC kefa na polozenie alebo zavesenie

Toilet brush holder, free standing or hanging

80 x 375 x 80 mm

118213092

bez DPH s DPH

84,0 € 100,8 €



## ■ Kruh

Ring towel holder

210 x 135 x 65 mm

118104062

bez DPH s DPH

34,0 € 40,8 €



## ■ Mydlovnička sklenená

Glass soap dish

100 x 48 x 130 mm

118108022

bez DPH s DPH

28,5 € 34,2 €



## ■ Dávkovač tekutého mydla, sklo

Soap dispenser with glass

60 x 155 x 95 mm, 200 ml

118209049

bez DPH s DPH

37,8 € 45,4 €



■ **Dávkočič tekutého mydla, na postavenie**  
 Soap dispenser with glass  
 105 x 170 x 70 mm, 230 ml  
 118109042  
 bez DPH      s DPH  
**37,8 €      45,4 €**



■ **Držiak na zubné kefky, sklo**  
 Holder with glass  
 85 x 100 x 120 mm  
 118110052  
 bez DPH      s DPH  
**28,5 €      34,2 €**



■ **Držiak na zubné kefky, sklo**  
 Holder with glass  
 60 x 100 x 95 mm  
 118210019  
 bez DPH      s DPH  
**28,5 €      34,2 €**



■ **Mydlovnička sklenená, na postavenie**  
 Glass soap dish  
 85 x 55 x 85 mm  
 140108191  
 bez DPH      s DPH  
**29,9 €      35,9 €**



■ **Dávkočič tekutého mydla, sklo, na postavenie**  
 Soap dispenser 200 ml, free standing  
 75 x 170 x 75 mm, 200 ml  
 140109161  
 bez DPH      s DPH  
**45,0 €      54,0 €**



■ **Držiak na zubné kefky, sklo, na postavenie**  
 Holder with glass  
 75 x 170 x 75 mm, 200 ml  
 140110061  
 bez DPH      s DPH  
**29,9 €      35,9 €**



■ **Držiak uterákov**  
 Towel holder  
 118104252 300 x 35 x 70 mm      bez DPH      s DPH  
 118104042 625 x 35 x 70 mm      **18,8 €      22,6 €**  
**41,9 €      50,2 €**



■ **Dvojitý držiak uterákov**  
 Double towel holder  
 625 x 35 x 120 mm  
 118104052  
 bez DPH      s DPH  
**64,4 €      77,3 €**

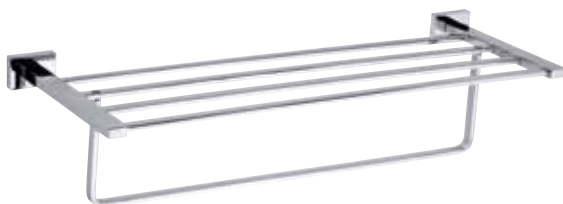

■ **Polička na uteráky s hrazdou**  
 Towel rack  
 585 x 140 x 210 mm  
 118104122  
 bez DPH      s DPH  
**145,6 €      174,7 €**



■ **Polička sklenená**  
 Glass shelf  
 600 x 35 x 140 mm  
 118102042  
 bez DPH      s DPH  
**30,5 €      36,6 €**

# OVAL

mosadz  
brass

chróm  
chrome

lesk  
polished

sklo  
glass



- **Vešiacik dvojitý**  
Double robe hook  
80 x 25 x 50 mm  
118406031  
bez DPH      s DPH  
**19,6 €      23,5 €**



- **Držiak toaletného papiera, bez krytu**  
Paper holder without cover  
190 x 30 x 65 mm  
118412021  
bez DPH      s DPH  
**26,1 €      31,4 €**



- **Držiak toaletného papiera, s krytom**  
Paper holder with cover  
125 x 130 x 60 mm  
118412011  
bez DPH      s DPH  
**27,5 €      33,0 €**



- **Kruh**  
Ring towel holder  
330 x 220 x 65 mm  
118404061  
bez DPH      s DPH  
**34,4 €      41,2 €**



- **Mydlovnička sklenená**  
Glass soap dish  
130 x 35 x 105 mm  
118408021  
bez DPH      s DPH  
**25,3 €      30,4 €**



- **Mydlovnička oválna**  
Soap dish oval  
135 x 30 x 130 mm  
118408041  
bez DPH      s DPH  
**31,6 €      37,9 €**



- **WC kefa na zavesenie, miska sklo**  
Wall mounted toilet brush with glass dish  
95 x 360 x 130 mm  
118413011  
bez DPH      s DPH  
**37,5 €      45,0 €**



- **Dávkač tekutého mydla, sklo**  
Soap dispenser  
75 x 170 x 110 mm, 200 ml  
118409011  
bez DPH      s DPH  
**34,4 €      41,2 €**



- **Držiak na zubné kefky, sklo**  
Holder with glass  
70 x 100 x 105 mm  
118410011  
bez DPH      s DPH  
**22,0 €      26,4 €**



- **Polička sklenená**  
Glass shelf  
520 x 30 x 145 mm  
118402031  
bez DPH      s DPH  
**35,6 €      42,8 €**



- **Držiak uterákov**  
Towel holder  
610 x 35 x 65 mm  
118404041  
bez DPH      s DPH  
**47,5 €      56,9 €**



- **Dvojitý držiak uterákov**  
Double towel holder  
650 x 30 x 110 mm  
118404051  
bez DPH      s DPH  
**71,5 €      85,7 €**



- **Polička na uteráky**  
Towel rack  
650 x 30 x 200 mm  
118412181  
bez DPH      s DPH  
**130,8 €      156,9 €**

# KERA

mosadz  
brass

bronz  
bronze

keramika  
ceramics

**BEMETA®**



- **Vešiačik**  
Single robe hook  
66 x 66 x 74 mm  
144706017  
bez DPH      s DPH  
**20,0 €      24,0 €**



- **Vešiačik dvojitý**  
Double robe hook  
66 x 66 x 74 mm  
144706037  
bez DPH      s DPH  
**21,0 €      25,2 €**



- **Držiak toaletného papiera rezervný**  
Spare paper holder  
66 x 181 x 74 mm  
144712037  
bez DPH      s DPH  
**30,6 €      36,7 €**



- **Držiak toaletného papiera bez krytu**  
Paper holder without cover  
136 x 102 x 93 mm  
144712027  
bez DPH      s DPH  
**30,6 €      36,7 €**



- **Držiak toaletného papiera s krytom**  
Paper holder with cover  
136 x 156 x 95 mm  
144712017  
bez DPH      s DPH  
**42,0 €      50,4 €**



- **Mydlovnička keramická**  
Soap dish holder  
107 x 66 x 150 mm  
144708027  
bez DPH      s DPH  
**28,5 €      34,2 €**



- **Dávkovač tekutého mydla**  
Soap dispenser  
72 x 190 x 125 mm, 230 ml  
144709017  
bez DPH      s DPH  
**47,0 €      56,4 €**



- **Držiak na zubné kefky**  
Toothbrush holder  
73 x 123 x 135 mm  
144710017  
bez DPH      s DPH  
**28,5 €      34,2 €**



- **Dvojitý držiak na zubné kefky**  
Double toothbrush holder  
168 x 107 x 95 mm  
144710027  
bez DPH      s DPH  
**44,0 €      52,8 €**



- **Kruh**  
Ring towel holder  
168 x 200 x 74 mm  
144704067  
bez DPH      s DPH  
**33,0 €      39,6 €**



- **WC kefa**  
Wall mounted toilet brush  
107 x 385 x 156 mm  
144713017  
bez DPH      s DPH  
**45,0 €      54,0 €**



- **Držiak uterákov**  
Towel holder  
666 x 66 x 74 mm  
144704047  
bez DPH      s DPH  
**51,5 €      61,8 €**



- **Dvojitý držiak uterákov**  
Double towel holder  
666 x 66 x 152 mm  
144704057  
bez DPH      s DPH  
**72,1 €      86,6 €**



- **Polička na uteráky**  
Towel rack  
666 x 66 x 245 mm  
144702187  
bez DPH      s DPH  
**106,0 €      127,2 €**



- **Polička sklenená**  
Glass shelf  
600 x 87 x 120 mm  
144702247  
bez DPH      s DPH  
**72,0 €      86,4 €**

# RETRO

mosadz  
brass

chróm  
chrome

lesk  
shiny

zlato  
gold

bronz  
bronze

sklo  
glass

chróm  
chrome



zlato/chróm  
gold/chrome



bronz  
bronze



## ■ Vešiacik

Single robe hook

65 x 65 x 65 mm

144306132 chróm/chrome  
144206138 zlato-chróm/gold-chrome  
144106137 bronz/bronze

| bez DPH | s DPH  |
|---------|--------|
| 12,7 €  | 15,2 € |
| 15,4 €  | 18,5 € |
| 17,2 €  | 20,6 € |

## ■ Vešiacik

Single robe hook

65 x 65 x 65 mm

144306012 chróm/chrome  
144206018 zlato-chróm/gold-chrome  
144106017 bronz/bronze

| bez DPH | s DPH  |
|---------|--------|
| 13,3 €  | 15,9 € |
| 15,8 €  | 18,9 € |
| 19,2 €  | 23,1 € |



## ■ Vešiacik dvojity

Double robe hook

65 x 65 x 65 mm

144306032 chróm/chrome  
144206038 zlato-chróm/gold-chrome  
144106037 bronz/bronze

| bez DPH | s DPH  |
|---------|--------|
| 13,6 €  | 16,3 € |
| 17,2 €  | 20,6 € |
| 20,6 €  | 24,7 € |

## ■ Držiak toaletného papiera, s krytom

Paper holder with cover

140 x 150 x 100 mm

144312012 chróm/chrome  
144212018 zlato-chróm/gold-chrome  
144112017 bronz/bronze

| bez DPH | s DPH  |
|---------|--------|
| 27,5 €  | 33,0 € |
| 31,9 €  | 38,3 € |
| 41,9 €  | 50,3 € |



## ■ Držiak toaletného papiera, bez krytu

Paper holder without cover

135 x 100 x 90 mm

144312022 chróm/chrome  
144212028 zlato-chróm/gold-chrome  
144112027 bronz/bronze

| bez DPH | s DPH  |
|---------|--------|
| 20,6 €  | 24,7 € |
| 23,3 €  | 27,9 € |
| 30,6 €  | 36,7 € |

## ■ Držiak toaletného papiera, rezervný

Spare toilet paper holder

65 x 170 x 65 mm

144312032 chróm/chrome  
144212038 zlato-chróm/gold-chrome  
144112037 bronz/bronze

| bez DPH | s DPH  |
|---------|--------|
| 19,9 €  | 23,9 € |
| 22,9 €  | 27,5 € |
| 30,6 €  | 36,7 € |





■ WC kefa na zavesenie, miska sklo

Wall mounted toilet brush with glass dish

|                                   | bez DPH | s DPH  |
|-----------------------------------|---------|--------|
| 110 x 360 x 145 mm                |         |        |
| 144313012 chróm/chrome            | 19,9 €  | 23,9 € |
| 144213018 zlato-chróm/gold-chrome | 33,7 €  | 40,4 € |
| 144113017 bronz/bronze            | 44,0 €  | 52,8 € |



■ Kruh

Ring towel holder

|                                   | bez DPH | s DPH  |
|-----------------------------------|---------|--------|
| 160 x 190 x 65 mm                 |         |        |
| 144304062 chróm/chrome            | 22,9 €  | 27,5 € |
| 144204068 zlato-chróm/gold-chrome | 25,8 €  | 30,9 € |
| 144104067 bronz/bronze            | 31,5 €  | 37,8 € |



■ Mydlovnička sklenená

Glass soap dish

|                                   | bez DPH | s DPH  |
|-----------------------------------|---------|--------|
| 110 x 65 x 138 mm                 |         |        |
| 144308022 chróm/chrome            | 20,6 €  | 24,7 € |
| 144208028 zlato-chróm/gold-chrome | 24,0 €  | 28,8 € |
| 144108027 bronz/bronze            | 27,2 €  | 32,6 € |



■ Mydlovnička obdĺžniková, drótená

Soap basket

|                                   | bez DPH | s DPH  |
|-----------------------------------|---------|--------|
| 140 x 65 x 142 mm                 |         |        |
| 144308162 chróm/chrome            | 23,6 €  | 28,3 € |
| 144208168 zlato-chróm/gold-chrome | 26,5 €  | 31,8 € |
| 144108167 bronz/bronze            | 35,5 €  | 42,6 € |



■ Dávkovač tekutého mydla MINI

Soap dispenser, MINI glass

|                                   | bez DPH | s DPH  |
|-----------------------------------|---------|--------|
| 75 x 150 x 120 mm, 200 ml         |         |        |
| 144309102 chróm/chrome            | 24,0 €  | 28,8 € |
| 144209108 zlato-chróm/gold-chrome | 24,7 €  | 29,7 € |
| 144109107 bronz/bronze            | 27,5 €  | 33,0 € |



■ Dávkovač tekutého mydla sklo

Soap dispenser

|                                   | bez DPH | s DPH  |
|-----------------------------------|---------|--------|
| 80 x 190 x 120 mm, 230 ml         |         |        |
| 144309012 chróm/chrome            | 38,8 €  | 46,6 € |
| 144209018 zlato-chróm/gold-chrome | 42,6 €  | 51,2 € |
| 144109017 bronz/bronze            | 44,8 €  | 53,7 € |



■ Držiak na zubné kefy, sklo

Holder with glass

|                                   | bez DPH | s DPH  |
|-----------------------------------|---------|--------|
| 70 x 95 x 115 mm                  |         |        |
| 144310012 chróm/chrome            | 20,6 €  | 24,7 € |
| 144210018 zlato-chróm/gold-chrome | 24,0 €  | 28,8 € |
| 144110017 bronz/bronze            | 27,5 €  | 33,0 € |



■ Dvojitý držiak na zubné kefy, sklo

Double glass holder

|                                   | bez DPH | s DPH  |
|-----------------------------------|---------|--------|
| 175 x 95 x 90 mm                  |         |        |
| 144310022 chróm/chrome            | 31,5 €  | 37,8 € |
| 144210028 zlato-chróm/gold-chrome | 33,7 €  | 40,4 € |
| 144110027 bronz/bronze            | 42,3 €  | 50,7 € |

# RETRO

mosadz  
brass

chróm  
chrome

lesk  
shiny

zlato  
gold

bronz  
bronze

sklo  
glass



## ■ Držiak uterákov

Towel holder

365 x 65 x 65 mm

144304012 chróm/chrome  
144204018 zlato-chróm/gold-chrome  
144104017 bronz/bronze

| bez DPH | s DPH  |
|---------|--------|
| 24,7 €  | 29,7 € |
| 33,7 €  | 40,4 € |
| 42,3 €  | 50,7 € |



## ■ Držiak uterákov

Towel holder

665 x 65 x 65 mm

144304042 chróm/chrome  
144204048 zlato-chróm/gold-chrome  
144104047 bronz/bronze

| bez DPH | s DPH  |
|---------|--------|
| 31,5 €  | 37,8 € |
| 38,5 €  | 46,2 € |
| 49,8 €  | 59,7 € |



## ■ Dvojité držiak uterákov

Double towel holder

665 x 65 x 120 mm

144304052 chróm/chrome  
144204058 zlato-chróm/gold-chrome  
144104057 bronz/bronze

| bez DPH | s DPH  |
|---------|--------|
| 56,4 €  | 67,7 € |
| 55,4 €  | 66,5 € |
| 67,3 €  | 80,8 € |



## ■ Polička na uteráky

Towel rack

665 x 65 x 225 mm

144302182 chróm/chrome  
144202188 zlato-chróm/gold-chrome  
144102187 bronz/bronze

| bez DPH | s DPH   |
|---------|---------|
| 60,2 €  | 72,2 €  |
| 67,7 €  | 81,2 €  |
| 106,7 € | 128,1 € |



## ■ Polička na uteráky s hrazdou

Towel rack

665 x 120 x 225 mm

144302092 chróm/chrome  
144202098 zlato-chróm/gold-chrome  
144102097 bronz/bronze

| bez DPH | s DPH   |
|---------|---------|
| 70,9 €  | 85,1 €  |
| 85,6 €  | 102,7 € |
| 132,2 € | 158,6 € |



## ■ Polička na uteráky dvojité

Double towel rack

665 x 165 x 225 mm

144302252 chróm/chrome  
144202258 zlato-chróm/gold-chrome  
144102257 bronz/bronze

| bez DPH | s DPH   |
|---------|---------|
| 106,7 € | 128,1 € |
| 117,7 € | 141,2 € |
| 178,4 € | 214,0 € |



## ■ Dvojité držiak uterákov

Double towel holder

665 x 125 x 115 mm

144304232 chróm/chrome  
144204238 zlato-chróm/gold-chrome  
144104237 bronz/bronze

| bez DPH | s DPH  |
|---------|--------|
| 56,4 €  | 67,7 € |
| 55,0 €  | 66,0 € |
| 78,1 €  | 93,7 € |



## ■ Polička sklenená

Glass shelf

600 x 87 x 120 mm

144302242 chróm/chrome  
144202248 zlato-chróm/gold-chrome  
144102247 bronz/bronze

| bez DPH | s DPH  |
|---------|--------|
| 45,7 €  | 54,8 € |
| 53,0 €  | 63,6 € |
| 70,9 €  | 85,1 € |



■ **Polička sklenená s hrazdou**

Glass shelf with rail

600 x 90 x 125 mm

144302262 chróm/chrome

144202268 zlato-chróm/gold-chrome

144102267 bronz/bronze

bez DPH

**51,9 €**

s DPH

**62,3 €**

**59,1 €**

**70,9 €**

**80,6 €**

**96,7 €**



■ **Polička sklenená dvojité**

Double glass shelf

400 x 420 x 120 mm

144301122 chróm/chrome

144201128 zlato-chróm/gold-chrome

144101127 bronz/bronze

bez DPH

**89,5 €**

s DPH

**107,4 €**

**99,8 €**

**119,7 €**

**174,5 €**

**209,4 €**



■ **Závesné kozmetické zrkadlo, bronz**

Cosmetic mirror, bronze

184 x 200 x 412 mm, ø 133 mm

106101697

bez DPH

**60,8 €**

s DPH

**70,2 €**



■ **Závesné kozmetické zrkadlo, zlato**

Cosmetic mirror, gold

184 x 200 x 412 mm, ø 133 mm

106101698

bez DPH

**60,8 €**

s DPH

**70,2 €**



■ **NEW** Guľatý odpadkový kôš

Trashbasket, bronze

170 x 260 x 170 mm, 3 l

104315023

bez DPH

**37,1 €**

s DPH

**44,5 €**



■ **NEW** Zásobník na papierové vreckovky

Handkerchief dispenser

250 x 130 x 75 mm

102303022

bez DPH

**37,0 €**

s DPH

**44,4 €**

chróm  
chrome

lesk  
polished

sklo  
glass



- **Vešiacik dvojitý**  
Double robe hook  
84 x 36 x 60 mm  
153106032  
bez DPH s DPH  
**7,6 € 9,1 €**



- **Držiak toaletného papiera, s krytom**  
Paper holder with cover  
117 x 140 x 49 mm  
153112012  
bez DPH s DPH  
**10,3 € 12,4 €**



- **Držiak toaletného papiera, bez krytu**  
Paper holder without cover  
126 x 90 x 40 mm  
153112022  
bez DPH s DPH  
**7,6 € 9,1 €**



- **Kruh**  
Ring towel holder  
228 x 150 x 60 mm  
153104062  
bez DPH s DPH  
**14,8 € 17,7 €**



- **Hrazda s vešiacikmi**  
Hool rail with hooks  
300 x 53 x 45 mm  
153105112  
bez DPH s DPH  
**14,5 € 17,4 €**



- **Mydlovnička sklenená**  
Glass soap dish  
100 x 40 x 110 mm  
153108022  
bez DPH s DPH  
**12,4 € 14,8 €**



- **WC kefa na zavesenie, miska sklo**  
Toilet brush holder  
105 x 375 x 135 mm  
153113012  
bez DPH s DPH  
**22,7 € 27,2 €**



- **Dávkač tekutého mydla**  
Soap dispenser  
77 x 150 x 100 mm, 250 ml  
153209049  
bez DPH s DPH  
**18,5 € 22,2 €**



- **Držiak na zubné kefky, sklo**  
Holder with glass  
77 x 97 x 100 mm  
153110052  
bez DPH s DPH  
**12,4 € 14,8 €**



- **Držiak uterákov**  
Towel holder  
550 x 36 x 62 mm  
153104042  
bez DPH s DPH  
**18,9 € 22,7 €**



- **Dvojitý držiak uterákov**  
Double towel holder  
550 x 36 x 117 mm  
153104052  
bez DPH s DPH  
**30,3 € 36,3 €**



- **Dvojitý držiak uterákov, otočný, na jednej rúčke**  
Double towel holder  
50 x 53 x 475 mm  
153104191  
bez DPH s DPH  
**12,4 € 14,8 €**



- **Držiak uterákov trojitý otočný**  
Three swing arm towel holder  
42 x 175 x 350 mm  
153104112  
bez DPH s DPH  
**16,4 € 19,6 €**



- **Polička sklenená**  
Glass shelf  
500 x 36 x 115 mm  
153102042  
bez DPH s DPH  
**14,5 € 17,4 €**

chróm  
chrome

lesk  
polished

sklo  
glass



- **Vešáček dvojitý**  
Double robe hook  
70 x 60 x 50 mm  
102406022  
bez DPH 6,1 € s DPH 7,4 €



- **Držák toaletného papiera, s krytom**  
Paper holder with cover  
138 x 135 x 59 mm  
102512012  
bez DPH 13,0 € s DPH 15,6 €



- **Držák toaletného papiera, s krytom**  
Paper holder with cover  
160 x 120 x 60 mm  
102412012  
bez DPH 13,0 € s DPH 15,6 €



- **Držák toaletného papiera rezervný**  
Paper holder without cover  
60 x 168 x 75 mm  
102512032  
bez DPH 8,9 € s DPH 10,7 €



- **Držák toaletního papíru bez krytu**  
Paper holder without cover  
180 x 125 x 60 mm  
102414012  
bez DPH 11,5 € s DPH 13,8 €



- **Držák na zubné kefky, sklo**  
Holder with glass  
68 x 95 x 115 mm  
102410012  
bez DPH 10,0 € s DPH 11,9 €



- **Mydlovnička sklenená**  
Glass soap dish  
110 x 60 x 138 mm  
102408023  
bez DPH 10,3 € s DPH 12,4 €



- **WC kefa na zavesenie, miska sklo**  
Toilet brush holder with glass dish  
115 x 385 x 140 mm  
102413012  
bez DPH 20,6 € s DPH 24,7 €



- **Dávkovač tekutého mydla, sklo**  
Glass soap dispenser wall model  
68 x 150 x 115 mm, 200 ml  
102408022  
bez DPH 19,8 € s DPH 23,8 €



- **Kruh**  
Ring towel holder  
212 x 170 x 55 mm  
102502062  
bez DPH 13,7 Kč s DPH 16,4 Kč



- **Kruh**  
Ring towel holder  
215 x 155 x 60 mm  
102402062  
bez DPH 11,5 € s DPH 13,8 €



- **Dvojitý držák uterákov, otočný na jednej rúčke**  
Double towel holder  
60 x 65 x 475 mm  
102404101  
bez DPH 19,8 € s DPH 23,8 €



- **Držák uterákov**  
Towel holder  
610 x 60 x 75 mm  
102404282  
bez DPH 18,4 € s DPH 22,1 €



- **Držák uterákov**  
Towel holder  
102402032 700 x 65 x 105 mm  
bez DPH 17,2 € s DPH 20,6 €  
102402042 620 x 60 x 85 mm  
bez DPH 16,4 € s DPH 19,7 €  
102402052a 520 x 60 x 85 mm  
bez DPH 17,1 € s DPH 20,5 €



- **Dvojitý držák uterákov**  
Double towel holder  
600 x 60 x 155 mm  
102410052  
bez DPH 27,5 € s DPH 33,0 €



- **Polička sklenená**  
Glass shelf  
600 x 22 x 125 mm  
102402242  
bez DPH 21,9 € s DPH 26,2 €



- **Polička s hrazdou**  
Towel rack  
620 x 60 x 150 mm  
102402243  
bez DPH 30,3 € s DPH 36,4 €

# TREND-i

mosadz  
brass

chróm  
chrome

lesk  
shiny

sklo  
glass

Príklad/Example:

104110018

- biela/white
- A** – zelená/green
- B** – čierna/black
- C** – červená/red
- D** – modrá/blue
- E** – tmavo modrá/dark blue
- F** – ružová/pink
- G** – oranžová/orange
- H** – žltá/yellow



■ RAL 9003  
Úchytka biela  
Replaceable wall holder, white  
52 x 52 x 50 mm  
104106028  
bez DPH s DPH  
9,8 € 11,7 €



■ RAL 6017, A  
Úchytka zelená  
Replaceable wall holder, green  
52 x 52 x 50 mm  
104106028A  
bez DPH s DPH  
9,8 € 11,7 €



■ RAL 9005, B  
Úchytka čierna  
Replaceable wall holder, black  
52 x 52 x 50 mm  
104106028B  
bez DPH s DPH  
9,8 € 11,7 €



■ RAL 3000, C  
Úchytka červená  
Replaceable wall holder, red  
52 x 52 x 50 mm  
104106028C  
bez DPH s DPH  
9,8 € 11,7 €



■ RAL 5015, D  
Úchytka modrá  
Replaceable wall holder, blue  
52 x 52 x 50 mm  
104106028D  
bez DPH s DPH  
9,8 € 11,7 €



■ RAL 5002, E  
Úchytka tmavo modrá  
Replaceable wall holder, dark blue  
52 x 52 x 50 mm  
104106028E  
bez DPH s DPH  
9,8 € 11,7 €



■ RAL 4003, F  
Úchytka ružová  
Replaceable wall holder, pink  
52 x 52 x 50 mm  
104106028F  
bez DPH s DPH  
9,8 € 11,7 €



■ RAL 2003, G  
Úchytka oranžová  
Replaceable wall holder, orange  
52 x 52 x 50 mm  
104106028G  
bez DPH s DPH  
9,8 € 11,7 €



■ RAL 1021, H  
Úchytka žltá  
Replaceable wall holder, yellow  
52 x 52 x 50 mm  
131567073H  
bez DPH s DPH  
9,8 € 11,7 €



■ Vešiačik  
Single robe hook  
52 x 52 x 50 mm  
104106028   
bez DPH s DPH  
9,8 € 11,7 €



■ Vešiačik dvojité  
Double robe hook  
52 x 52 x 50 mm  
104106038   
bez DPH s DPH  
10,1 € 12,2 €



■ Kruh  
Ring towel holder  
160 x 190 x 50 mm  
104104068   
bez DPH s DPH  
20,7 € 24,8 €



■ Držiak toaletného papiera, bez krytu

Paper holder without cover

135 x 100 x 65 mm

104112048

bez DPH s DPH

13,6 € 16,4 €



■ Držiak toaletného papiera, s krytom

Paper holder with cover

135 x 155 x 70 mm

104112018

bez DPH s DPH

24,2 € 29,0 €



■ Držiak toaletného papiera, rezervný

Spare toilet paper holder

54 x 152 x 68 mm

104112038

bez DPH s DPH

17,2 € 20,6 €



■ Držiak na zubné kefky, sklo

Holder with glass

70 x 95 x 105 mm

104110018

bez DPH s DPH

17,2 € 20,6 €



■ Mydlovnička obdĺžniková, kovová

Soap dish rectangular

125 x 52 x 115 mm

104108082

bez DPH s DPH

20,7 € 24,8 €



■ Dávkovač tekutého mydla, sklo

Soap dispenser with glass

80 x 190 x 133 mm, 230 ml

104109018

bez DPH s DPH

34,6 € 41,6 €



■ WC kefa na zavesenie, miska sklo

Wall mounted toilet brush with glass dish

95 x 360 x 140 mm

104113018

bez DPH s DPH

24,2 € 29,0 €



■ Polička sklenená, s výklopnou hrazdou

Glass shelf with tiltable rail

600 x 55 x 130 mm

104102208

bez DPH s DPH

41,7 € 50,0 €



■ Držiak uterákov

Towel holder

500 x 52 x 70 mm

104104028

bez DPH s DPH

27,7 € 33,2 €



■ Dvojitý držiak uterákov

Double towel holder

655 x 52 x 110 mm

104104058

bez DPH s DPH

38,2 € 45,8 €

# FIX!

chróm chrome    lesk polished    guma rubber



■ **Vešiačik**  
Single robe hook  
66 x 66 x 57 mm  
103606131  
bez DPH    s DPH  
**9,6 €    11,6 €**



■ **Kruh**  
Ring towel holder  
165 x 198 x 67 mm  
103604061  
bez DPH    s DPH  
**18,9 €    22,7 €**



■ **Držiak toaletného papiera s krytom**  
Paper holder with cover  
142 x 148 x 95 mm  
103612011  
bez DPH    s DPH  
**26,9 €    32,2 €**



■ **Držiak toaletného papiera rezervný**  
Spare paper holder  
66 x 182 x 89 mm  
103612031  
bez DPH    s DPH  
**23,8 €    28,5 €**



■ **Držiak uterákov**  
Towel holder  
666 x 66 x 66 mm  
103604041  
bez DPH    s DPH  
**26,2 €    31,4 €**



■ **WC kefa valcová, malá**  
Toilet brush holder  
90 x 365 x 133 mm  
103613071  
bez DPH    s DPH  
**32,0 €    38,4 €**

! Do vyprodání zásob. | Till sold out.

chróm chrome    lesk polished    guma rubber



■ **WC kefa s rukoväťou**  
Spare WC brush with handle  
70 x 270 x 70 mm  
131567448  
bez DPH    s DPH  
**9,8 €    11,7 €**

Vhodné pre:  
Usable for:

GAMMA, TASI, SOLO, OMEGA,  
BETA, VIA, TREND-i, PLAZA,  
OVAL, NIKI



■ **WC kefa**  
Spare WC brush with handle  
70 x 102 x 70 mm  
131567447  
bez DPH    s DPH  
**6 €    7,2 €**

## GUMOVÁ KRYTKA

guma rubber



■ **Gumová krytka pre WC kefu; biela**  
Rubber cover  
75 x 6 x 75 mm  
131567412    biela/white  
bez DPH    s DPH  
**1,6 €    2 €**



■ **Gumová krytka pre WC kefu; čierna**  
Rubber cover  
75 x 6 x 75 mm  
13156741    čierna/black  
bez DPH    s DPH  
**1,6 €    2 €**

■ **Vhodné pre/Usable for:**

104113014  
104913094  
104113010  
154113012  
144713017  
104836012  
104113102  
104113107  
104113012  
104113017  
104913112  
104913117  
104913092

132113012  
132113017  
102313075  
102313079  
104113105  
104113109  
104113015  
104113019  
104113018  
144202128  
144313012  
144113017  
104913090



mosadz  
brass

chróm  
chrome

lesk  
shiny

sklo  
glass



- Držiak uterákov na vykurovacie teleso, chróm  
Towel holder for radiator  
600 x 69 x 215 mm  
134504232  
bez DPH s DPH  
**25,8 € 31,0 €**



- Držiak uterákov na vykurovacie teleso, biely  
Towel holder for radiator, white  
600 x 69 x 215 mm  
134504235  
bez DPH s DPH  
**18,8 € 22,5 €**



- Vešiacik válcový magnetický  
Magnetic single robe hook  
54 x 54 x 57 mm  
104106182  
bez DPH s DPH  
**15,5 € 18,6 €**



- Držiak uterákov magnetický  
Magnetic towel holder  
260 x 54 x 63 mm  
104104262  
bez DPH s DPH  
**32,6 € 39,2 €**



- Držiak uterákov magnetický  
Magnetic towel holder  
430 x 54 x 63 mm  
104104272  
bez DPH s DPH  
**34,3 € 41,2 €**



- Držiak uterákov magnetický  
Magnetic towel holder  
550 x 54 x 63 mm  
104104282  
bez DPH s DPH  
**39,3 € 47,1 €**



- Vešiacik na vykurovacie teleso  
Radiator hook  
170 x 55 x 70 mm  
104506122 lesk/polished  
104506124 biely/white  
bez DPH s DPH  
**10,3 € 12,3 €**



- Držiak na uteráky na vykurovacie teleso s vešiakmi, lesk  
Radiator adjustable towel holder with hooks, polished  
355 x 40 x 90 mm  
134504222  
bez DPH s DPH  
**26,8 € 32,1 €**



- Držiak na uteráky na vykurovacie teleso s vešiakmi, biely  
Radiator adjustable towel holder with hooks, white  
355 x 40 x 90 mm  
134504225  
bez DPH s DPH  
**26,8 € 32,1 €**



- Držiak na uteráky na vykurovacie teleso SINGLE, lesk  
Radiator towel holder SINGLE, polished  
610 x 48 x 140 mm  
101204161  
bez DPH s DPH  
**32,3 € 38,8 €**



- Držiak na uteráky na vykurovacie teleso SINGLE, biely  
Radiator towel holder SINGLE, white  
610 x 48 x 140 mm  
101204164  
bez DPH s DPH  
**17,8 € 21,4 €**



- Držiak na uteráky na vykurovacie teleso DOUBLE, biely  
Radiator towel holder DOUBLE, white  
590 x 75 x 150 mm  
101604174  
bez DPH s DPH  
**20,0 € 24,0 €**



- Držiak na uteráky na vykurovacie teleso, rovný, lesk  
Straight adjustable towel bar  
600 x 40 x 90 mm  
134504202  
bez DPH s DPH  
**23,0 € 27,6 €**



- Držiak na uteráky na vykurovacie teleso, zahnutý, lesk  
Adjustable towel bar, for radiator  
600 x 40 x 95 mm  
134504212  
bez DPH s DPH  
**25,0 € 30,0 €**

# CYTRO

- nerez stainless
- mosadz brass
- chróm chrome
- plast plastic
- lesk shiny



- Polička do sprchy  
Soap basket, polished  
250 x 75 x 110 mm  
146208052  
bez DPH s DPH  
46,4 € 55,7 €



- Polička do sprchy  
Soap basket, polished  
400 x 75 x 110 mm  
146208062  
bez DPH s DPH  
63,6 € 76,4 €



- Polička do sprchy  
Soap basket, polished  
146208072 260 x 80 x 200 mm  
bez DPH s DPH  
49,9 € 59,8 €  
146208082 340 x 80 x 250 mm  
bez DPH s DPH  
68,7 € 82,4 €



- Polička do sprchy  
Soap basket, polished  
146208092 270 x 75 x 200 mm  
bez DPH s DPH  
56,8 € 68,2 €  
146208102 240 x 70 x 240 mm  
bez DPH s DPH  
68,7 € 82,4 €



- Polička do sprchy so stierkou  
Soap basket with spatula, polished  
223 x 65 x 105 mm  
102208292  
bez DPH s DPH  
65,1 € 78,1 €



- Polička do sprchy so stierkou  
Soap basket with plastic tray, polished  
225 x 63 x 115 mm  
102208302  
bez DPH s DPH  
48,0 € 57,6 €



- Polička do sprchy s plastovou vaničkou  
Soap basket with plastic tray, polished  
280 x 75 x 160 mm  
102208272  
bez DPH s DPH  
39,6 € 47,5 €



- Polička do sprchy, rohová  
Corner soap basket, polished  
280 x 75 x 160 mm  
102208282  
bez DPH s DPH  
54,4 € 65,3 €



- Mydlovnička obdĺžniková, lesk  
Soap basket, polished  
300 x 26 x 115 mm  
102308081  
bez DPH s DPH  
32,0 € 38,4 €



- Mydlovnička trojuholníková, lesk  
Corner soap basket, polished  
102308051 205 x 25 x 110 mm bez DPH s DPH  
16,1 € 19,3 €  
102308261 262 x 35 x 142 mm bez DPH s DPH  
19,6 € 23,5 €



- Mydlovnička trojuholníková, lesk  
Corner soap basket, polished  
311 x 45 x 210 mm  
102308061  
bez DPH s DPH  
34,4 € 41,2 €



- Polička do sprchy rohová, nerez  
Corner soap basket  
340 x 65 x 205 mm  
146208192  
bez DPH s DPH  
52,5 € 63,0 €



- Polička do sprchy rohová, nerez  
Corner soap basket  
335 x 65 x 250 mm  
146208212  
bez DPH s DPH  
58,4 € 70,0 €



- Mydlovnička trojuholníková, plast/nerez lesk  
Soap basket, plastic/stainless  
305 x 55 x 220 mm  
146208016  
bez DPH s DPH  
28,4 € 34,1 €



- Mydlovnička obdĺžniková, plast/nerez lesk  
Soap basket, plastic/stainless  
300 x 55 x 125 mm  
146208036  
bez DPH s DPH  
28,4 € 34,1 €



■ **Polička do sprchy rohová, akryl**  
Acrylic soap dish white  
260 x 75 x 195 mm  
146208376  
bez DPH s DPH  
**41,2 € 49,4 €**



■ **Polička do sprchy, akryl**  
Acrylic soap dish black  
250 x 75 x 105 mm  
146208406  
bez DPH s DPH  
**41,2 € 49,4 €**



■ **Polička do sprchy rohová, akryl**  
Acrylic soap dish black  
260 x 75 x 195 mm  
146208386  
bez DPH s DPH  
**41,2 € 49,4 €**



■ **Polička do sprchy, akryl**  
Acrylic soap dish black  
250 x 75 x 105 mm  
146208396  
bez DPH s DPH  
**41,2 € 49,4 €**



■ **Mydlovnička trojuholníková, plast/lesk**  
Corner soap basket, plastic/polished  
315 x 67 x 235 mm  
102308216  
bez DPH s DPH  
**34,4 € 41,2 €**



■ **Mydlovnička obdĺžniková, plast/lesk**  
Soap basket, plastic/polished  
279 x 65 x 139 mm  
102308226  
bez DPH s DPH  
**30,5 € 36,6 €**



■ **Polička do sprchy, chróm**  
Soap basket  
146208112 320 x 60 x 130 mm  
bez DPH s DPH  
**30,5 € 36,6 €**  
146208122 210 x 60 x 135 mm  
bez DPH s DPH  
**24,8 € 29,7 €**



■ **Polička do sprchy, chróm**  
Soap basket  
146208142 300 x 108 x 135 mm  
bez DPH s DPH  
**30,8 € 37,0 €**  
146208152 210 x 108 x 135 mm  
bez DPH s DPH  
**27,4 € 32,9 €**



■ **Polička do sprchy, chróm**  
Soap basket  
155 x 25 x 100 mm  
146208132  
bez DPH s DPH  
**17,1 € 20,5 €**



■ **Polička do sprchy, chróm**  
Soap basket  
405 x 70 x 120 mm  
146208252  
bez DPH s DPH  
**34,3 € 41,1 €**



■ **Polička do sprchy, chróm**  
Soap basket  
305 x 90 x 145 mm  
146208262  
bez DPH s DPH  
**29,1 € 34,9 €**



■ **Polička do sprchy, chróm**  
Soap basket  
305 x 70 x 125 mm  
146208272  
bez DPH s DPH  
**27,4 € 32,9 €**



■ **Polička do sprchy, chróm**  
Soap basket  
305 x 40 x 145 mm  
146208282  
bez DPH s DPH  
**24,8 € 29,8 €**



■ **Polička do sprchy, chróm**  
Soap basket  
250 x 60 x 115 mm  
146208172  
bez DPH s DPH  
**41,2 € 49,4 €**



■ **Polička do sprchy, chróm**  
Soap basket  
250 x 75 x 110 mm  
146208362  
bez DPH s DPH  
**37,7 € 45,3 €**

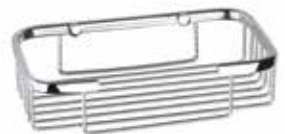

■ **Polička do sprchy, chróm**  
Soap basket  
210 x 50 x 120 mm  
146208292  
bez DPH s DPH  
**32,7 € 39,3 €**

# CYTRO

nerez  
stainless

mosadz  
brass

chróm  
chrome

plast  
plastic

lesk  
shiny



■ Mydlovnička do sprchy, chróm

Soap basket

130 x 30 x 90 mm

146208302

bez DPH s DPH

13,6 € 16,3 €



■ Polička do sprchy rohová, chróm

Soap basket

300 x 80 x 230 mm

146208312

bez DPH s DPH

27,4 € 32,9 €



■ Polička do sprchy rohová, chróm

Corner soap basket

265 x 40 x 205 mm

146208322

bez DPH s DPH

24,8 € 29,7 €



■ Polička do sprchy rohová, chróm

Corner soap basket

230 x 70 x 230 mm

146208332

bez DPH s DPH

34,4 € 41,2 €



■ Polička do sprchy rohová, chróm

Corner soap basket, polished

260 x 70 x 185 mm

146208352

bez DPH s DPH

39,5 € 47,4 €



■ Polička do sprchy rohová, chróm

Corner soap basket, polished

173 x 30 x 111 mm

106308172

bez DPH s DPH

19,2 € 23,1 €



mat/matt



lesk/polished

■ Polička do sprchy rohová

Corner soap basket, polished

220 x 35 x 130 mm

104308172 mat/matt

bez DPH s DPH

20,3 € 24,3 €

104308175 lesk/polished

bez DPH s DPH

17,7 € 21,3 €



■ Polička do sprchy rohová, chróm

Corner soap basket, polished

245 x 60 x 150 mm

102308122

bez DPH s DPH

21,3 € 25,5 €



■ Závesná polička do sprchy, lesk

Shower basket double, polished

170 x 700 x 260 mm

104702172

bez DPH s DPH

75,7 € 90,8 €



■ Polička do sprchy rohová, chróm

Corner soap basket, polished

250 x 60 x 155 mm

146208342

bez DPH s DPH

19,6 € 23,6 €



lesk/polished

mat/matt

■ Polička do sprchy

Soap basket

270 x 40 x 110 mm

146102272 lesk/polished

146102275 mat/matt

bez DPH s DPH

49,2 € 59,1 €



■ Polička do sprchy, chróm

Soap basket, polished

230 x 30 x 100 mm

102308072

bez DPH s DPH

19,5 € 23,4 €



■ Polička do sprchy, chróm

Soap basket, polished

300 x 30 x 130 mm

102308082

bez DPH s DPH

21,3 € 25,5 €



■ Polička do sprchy, chróm

Soap basket, polished

200 x 30 x 115 mm

102308112

bez DPH s DPH

20,3 € 24,3 €



■ Mýdlenka drátěná obdélková, mat  
Soap basket, matt  
232 x 30 x 122 mm  
104308072  
bez DPH s DPH  
**20,6 € 24,7 €**



■ Polička do sprchy, chróm  
Soap basket  
220 x 230 x 108 mm  
146208182  
bez DPH s DPH  
**56,8 € 68,2 €**



■ Polička do sprchy, nerez  
Shower basket double, polished  
305 x 385 x 115 mm  
102308241  
bez DPH s DPH  
**85,6 € 102,7 €**



■ Polička do sprchy, chróm  
Soap basket  
250 x 455 x 160 mm  
146208432  
bez DPH s DPH  
**56,3 € 67,5 €**



■ Mydlovnička na postavenie, lesk  
Soap dish polished surface  
95 x 30 x 75 mm  
104708182  
bez DPH s DPH  
**7,4 € 8,9 €**



■ Polička do sprchy rohová, chróm  
Double soap basket, corner model  
420 x 460 x 315 mm  
146208222  
bez DPH s DPH  
**121,2 € 145,5 €**



■ Polička do sprchy rohová, chróm  
Double soap basket, corner model  
440 x 445 x 255 mm  
146208202  
bez DPH s DPH  
**101,6 € 121,9 €**



■ Polička do sprchy, chróm  
Soap basket  
250 x 705 x 205 mm  
146208422  
bez DPH s DPH  
**93,3 € 112,0 €**



■ Polička trojuholníková, dvojité, lesk  
Double soap basket, corner model, polished  
260 x 325 x 155 mm  
102308132  
bez DPH s DPH  
**37,5 € 45,0 €**



■ Polička do sprchy rohová, chróm  
Double soap basket  
220 x 500 x 205 mm  
146208232  
bez DPH s DPH  
**68,7 € 82,4 €**



■ Polička do sprchy, chróm  
Soap basket  
278 x 480 x 149 mm  
146208242  
bez DPH s DPH  
**68,7 € 82,4 €**

# SAMOSTATNE STOJACE DOPLNKY / FREE STANDING ACCESSORIES

mosadz  
brass

chróm  
chrome

lesk  
polished

sklo  
glass

## OKRÚHLE / ROUND



- Držiak na zubné kefky, sklo  
Glass holder with glass  
80 x 100 x 80 mm  
138110061  
bez DPH s DPH  
**16,8 € 20,2 €**



- Mydlovnička sklenená  
Glass soap dish  
110 x 60 x 110 mm  
138108191  
bez DPH s DPH  
**16,8 € 20,2 €**



- Dávkovač tekutého mydla, sklo  
Soap dispenser  
80 x 160 x 80 mm, 200 ml  
138109161  
bez DPH s DPH  
**30,9 € 37,1 €**

## HRANATÉ / SQUARE



- Držiak na zubné kefky, sklo  
Glass holder with glass  
75 x 110 x 75 mm  
140110061  
bez DPH s DPH  
**29,9 € 35,9 €**



- Mydlovnička sklenená  
Glass soap dish  
85 x 55 x 85 mm  
140108191  
bez DPH s DPH  
**29,9 € 35,9 €**



- Dávkovač tekutého mydla, sklo  
Soap dispenser  
75 x 170 x 75 mm, 200 ml  
140109161  
bez DPH s DPH  
**45,0 € 54,0 €**



- Stojan s držiakom na toal. papier a WC kefou  
Free standing toilet paper and brush holder  
250 x 730 x 250 mm  
104836012  
bez DPH s DPH  
**112,4 € 134,9 €**

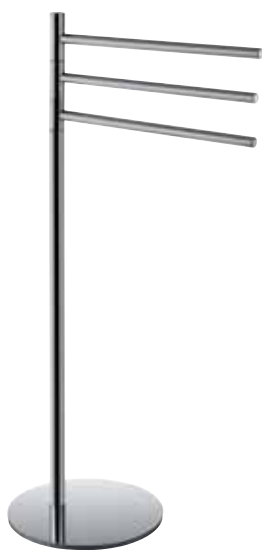

- Stojan s držiakom na uteráky, trojitý, otočný  
Free standing 3 swing  
370 x 850 x 250 mm  
104836032  
bez DPH s DPH  
**123,6 € 148,3 €**



- Stojan s držiakom na toal. papier a WC kefou  
Free standing toilet paper and brush holder  
155 x 710 x 255 mm  
132836012  
bez DPH s DPH  
**130,5 € 156,6 €**



- Stojan s držiakom na uteráky, dvojité  
Free standing double tower holder  
150 x 800 x 400 mm  
132836022  
bez DPH s DPH  
**127,4 € 152,8 €**

# KOSMETICKÁ ZRCÁTKA /BATHROOM MIRRORS

**BEMETA®**

mosadz brass chróm chrome lesk polished sklo glass



## ■ Kosmetické zrkadlo, nalepenie + magnet

Glue-on mirror

151 x 17 x 151 mm, ø 131 mm

112101150

bez DPH s DPH

34,4 € 41,2 €



## ■ Závesné kosmetické zrkadlo

Cosmetic mirror, bronze

238 x 255 x 465 mm, ø 182 mm

112201518

bez DPH s DPH

85,7 € 102,8 €



## ■ Závesné kosmetické zrkadlo

Cosmetic mirror

185 x 260 x 420 mm, ø 135 mm

106301122

bez DPH s DPH

27,5 € 33,0 €



## ■ Závesné kosmetické zrkadlo, mat

Cosmetic mirror matt

184 x 200 x 412 mm, ø 133 mm

106301705

bez DPH s DPH

60,8 € 73,0 €



## ■ Závesné kosmetické zrkadlo, bronz

Cosmetic mirror, bronze

184 x 200 x 412 mm, ø 133 mm

106101697

bez DPH s DPH

60,8 € 73,0 €



## ■ Závesné kosmetické zrkadlo, zlato

Cosmetic mirror, gold

184 x 200 x 412 mm, ø 133 mm

106101698

bez DPH s DPH

60,8 € 73,0 €



## ■ Závesné kosmetické zrkadlo

Cosmetic mirror

230 x 260 x 350 mm, ø 180 mm

112201522

bez DPH s DPH

41,6 € 49,9 €



## ■ Závesné kosmetické zrkadlo

Cosmetic mirror

230 x 310 x 450 mm, ø 190 mm

112201510

bez DPH s DPH

98,0 € 117,6 €



## ■ Závesné kosmetické zrkadlo

Cosmetic mirror

230 x 310 x 450 mm, ø 190 mm

112201514

bez DPH s DPH

65,1 € 78,1 €



## ■ Závesné kosmetické zrkadlo s LED osvetlením

Cosmetic bath mirror with LED light

255 x 200 x 400 mm, ø 200 mm

112101149

bez DPH s DPH

162,3 € 194,8 €



## ■ Závesné kosmetické zrkadlo s LED osvetlením

Cosmetic bath mirror with LED light

255 x 200 x 400 mm, ø 200 mm

112101140

bez DPH s DPH

195,8 € 235,0 €

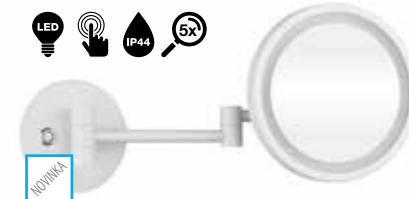

## ■ Závesné kosmetické zrkadlo s LED osvetlením

Cosmetic bath mirror with LED light

255 x 200 x 400 mm, ø 200 mm

112101144

bez DPH s DPH

195,8 € 235,0 €

! Do vypredania zásob./Till sold out.

# KOSMETICKÁ ZRCÁTKA/BATHROOM MIRRORS

mosadz  
brass

chróm  
chrome

lesk  
polished

sklo  
glass



- Závěsné kosmetické zrkadlo s LED osvetlením  
Cosmetic bath mirror with LED  
260 x 200 x 400 mm, ø 180 mm; 5,6 W  
116101142  
bez DPH s DPH  
**162,1 € 194,5 €**



NOVINKA

- Závěsné kosmetické zrkadlo s LED osvetlením  
Cosmetic mirror, plastic cover  
215 x 215 x 418 mm, ø 203 mm  
116301522  
bez DPH s DPH  
**108,3 € 130,0 €**

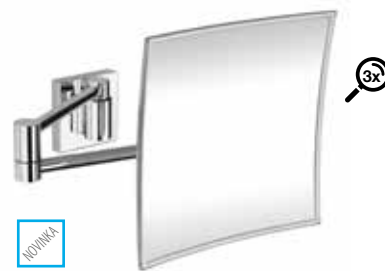

NOVINKA

- Závěsné kosmetické zrkadlo, plastový kryt  
Cosmetic mirror, plastic cover  
215 x 215 x 462 mm, ø 203 mm  
116301212  
bez DPH s DPH  
**116,7 € 140,0 €**



NOVINKA

- Závěsné kosmetické zrkadlo s LED osvetlením, plastový kryt  
Cosmetic mirror, LED light, plastic cover  
260 x 230 x 425 mm, ø 225 mm  
116301802 2 druhy svetla/types of light  
bez DPH s DPH  
**192,5 € 231,0 €**



NOVINKA

- Závěsné kosmetické zrkadlo s LED osvetlením, plastový kryt  
Cosmetic mirror, LED light, plastic cover  
280 x 225 x 470 mm  
116301812 2 druhy svetla/types of light  
bez DPH s DPH  
**198,3 € 240,0 €**



- Závěsné kosmetické zrkadlo s LED osvetleným ramčekom  
Cosmetic bath mirror with LED  
260 x 200 x 290 mm  
112102672  
bez DPH s DPH  
**194,4 € 233,3 €**



- Závěsné kosmetické zrkadlo  
Cosmetic mirror  
140 x 140 x 220 mm, ø 140 mm  
112101521  
bez DPH s DPH  
**40,9 € 49,1 €**



- Závěsné kosmetické zrkadlo s LED osvetlením  
Cosmetic bath mirror with LED light  
225 x 200 x 365 mm, ø 200 mm, 5,6 W  
116101770  
bez DPH s DPH  
**220,0 € 264,0 €**



- Závěsné kosmetické zrkadlo  
Cosmetic mirror  
230 x 310 x 450 mm, ø 190 mm  
112201512  
bez DPH s DPH  
**47,1 € 56,5 €**



- Závěsné kosmetické zrkadlo  
Cosmetic mirror  
230 x 310 x 450 mm, ø 190 mm  
112201512Wbronz  
bez DPH s DPH  
**46,0 € 55,2 €**



- Závěsné kosmetické zrkadlo s LED osvetlením  
Cosmetic mirror with LED light, IP44, touch sensor  
200 x 200 x 430 mm, ø 200 mm  
116101772  
bez DPH s DPH  
**192,5 € 231,0 €**





■ **Závesné kozmetické zrkadlo**  
Cosmetic mirror  
200 x 240 x 125 mm, ø 200 mm  
112201332  
bez DPH s DPH  
**46,3 € 55,5 €**



■ **Závesné kozmetické zrkadlo s kĺbom 360°**  
Cosmetic mirror  
200 x 230 x 90 mm, ø 200 mm  
116201332  
bez DPH s DPH  
**53,3 € 64,0 €**



■ **Závesné kozmetické zrkadlo**  
Cosmetic mirror  
140 x 140 x 80 mm, ø 140 mm  
112101121  
bez DPH s DPH  
**34,4 € 41,2 €**



■ **Závesné kozmetické zrkadlo**  
Cosmetic mirror  
155 x 310 x 420 mm  
112201612  
bez DPH s DPH  
**44,0 € 52,8 €**



■ **Závesné kozmetické zrkadlo**  
Cosmetic mirror  
130 x 240 x 100 mm  
112201222  
bez DPH s DPH  
**47,9 € 57,5 €**



■ **Závesné kozmetické zrkadlo s kĺbom 360°**  
Cosmetic mirror  
130 x 240 x 100 mm  
116201222  
bez DPH s DPH  
**53,3 € 64,0 €**



■ **Závesné kozmetické zrkadlo s LED osvetlením**  
Cosmetic mirror, with LED light  
200 x 200 x 430 mm, ø 200 mm  
112102682  
bez DPH s DPH  
**161,4 € 193,7 €**



■ **Závesné kozmetické zrkadlo s LED osvetlením**  
Cosmetic bath mirror with LED light  
260 x 200 x 400 mm  
116101202  
bez DPH s DPH  
**189,2 € 227,0 €**



■ **Závesné kozmetické zrkadlo s LED osvetlením**  
Cosmetic mirror  
205 x 205 x 400 mm; 5,6 W  
112101202 s osvetlením LED/with LED light  
112101208 dva typy osvetlení/with 2 types of light  
bez DPH s DPH  
**197,6 € 237,1 €**



■ **Závesné kozmetické zrkadlo na tyči**  
Cosmetic mirror  
200 x 510 x 175 mm, ø 200 mm  
116201792  
bez DPH s DPH  
**132,5 € 159,0 €**



■ **Závesné kozmetické zrkadlo na tyči**  
Cosmetic bath mirror  
200 x 535 x 140 mm, ø 200 mm  
112201172  
bez DPH s DPH  
**131,8 € 158,2 €**



■ **Závesné kozmetické zrkadlo na tyči s LED osvetlením**  
Cosmetic mirror  
200 x 550 x 140 mm, ø 200 mm, 5,6 W  
112101162  
bez DPH s DPH  
**162,5 € 195,0 €**  
112101168  
bez DPH s DPH  
**191,1 Kč 229,3 Kč**

# KOSMETICKÁ ZRCÁTKA/BATHROOM MIRRORS

mosadz  
brass

chróm  
chrome

lesk  
polished

sklo  
glass



## ■ Závěsné kozmetické zrkadlo s LED osvetlením

Cosmetic mirror rectangular with LED light  
200 x 200 x 430 mm, ø 200 mm  
116102672

bez DPH s DPH  
**220,0 € 264,0 €**



## ■ Závěsné kozmetické zrkadlo s LED osvetlením

Cosmetic mirror with 2x LED light, IP44, touch sensor  
200 x 200 x 430 mm, ø 200 mm  
116101802

bez DPH s DPH  
**166,7 € 200,0 €**



## ■ Kozmetické zrkátko na tyči hranaté

Cosmetic bath mirror with LED  
200 x 505 x 175 mm 200 x 505 x 175 mm, LED  
112201192 112101182

bez DPH s DPH bez DPH s DPH  
**165,6 € 198,8 € 231,7 € 278,0 €**



NOVINKA

## ■ Kozmetické zrkadlo na postavenie, plastový kryt

Cosmetic bath mirror free standing, plastic cover  
215 x 375 x 145 mm  
116401312

bez DPH s DPH  
**68,8 € 82,6 €**



NOVINKA

## ■ Kozmetické zrkadlo na postavenie, plastový kryt

Cosmetic bath mirror free standing, plastic cover  
215 x 375 x 145 mm, ø 215 mm  
116401412

bez DPH s DPH  
**64,2 € 77,0 €**



## ■ Kozmetické zrkadlo obojstranné na postavenie

Cosmetic bath mirror free standing  
112201232 235 x 385 x 140 mm, ø 135 mm

bez DPH s DPH  
**31,4 € 37,7 €**

112201252 235 x 385 x 140 mm, ø 180 mm  
**37,9 € 45,5 €**



## ■ Kozmetické zrkadlo na postavenie

Cosmetic mirror  
185 x 370 x 115 mm  
112201312

bez DPH s DPH  
**38,5 € 46,1 €**



## ■ Kozmetické zrkadlo na postavenie

Cosmetic mirror  
230 x 390 x 150 mm, ø 180 mm  
112201412

bez DPH s DPH  
**39,2 € 47,0 €**



## ■ Kozmetické zrkadlo, jednostranné, hranaté, na postavenie

Cosmetic mirror rectangular single side, free standing  
185 x 370 x 115 mm  
116201312

bez DPH s DPH  
**53,3 € 64,0 €**



## ■ Kozmetické zrkadlo, ø 180 mm, jednostranné, na postavenie

Cosmetic mirror round single side, free standing  
185 x 370 x 115 mm, ø 180 mm  
116201252

bez DPH s DPH  
**1 280 € 1 549 €**



## ■ Kozmetické zrkadlo obojstranné s LED osvetlením na postavenie

Cosmetic mirror with LED light free standing  
225 x 355 x 120 mm, ø 180 mm  
112101622

bez DPH s DPH  
**107,5 € 129,0 €**

# LED PODSVIETENÉ ZRKADLÁ

## LED BACKLIT MIRRORS

**BEMETA®**

mosadz  
brass

chróm  
chrome

lesk  
polished

sklo  
glass



NOVINKA



■ 600 x 600 x 40 mm, 3 W  
128101829  
bez DPH s DPH  
**177,5 € 213 €**



NOVINKA



■ 900 x 600 x 30 mm, 3 W  
128201869  
bez DPH s DPH  
**291,0 € 349,0 €**



NOVINKA



■ 550 x 550 x 35 mm, 3 W  
128101849  
bez DPH s DPH  
**309,5 € 371,5 €**

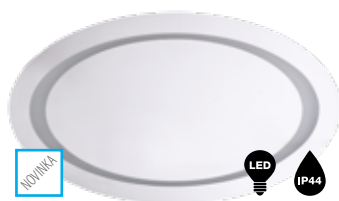

NOVINKA



■ 800 x 500 x 50 mm, 3 W  
128301019  
bez DPH s DPH  
**275,1 € 330,1 €**



NOVINKA



■ 660 x 660 x 50 mm, 3 W  
128301049  
bez DPH s DPH  
**308,2 € 369,8 €**



NOVINKA



■ 1200 x 600 x 36 mm, 6 W  
127101069  
bez DPH s DPH  
**344,0 € 412,8 €**



■ 600 x 800 x 35 mm, 3 W  
127201659  
bez DPH s DPH  
**160,3 € 192,4 €**



NOVINKA



■ 600 x 800 x 36 mm, 6 W  
127101809  
bez DPH s DPH  
**275,1 € 330,1 €**

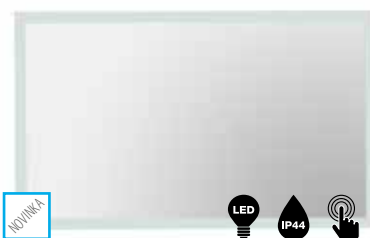

NOVINKA



■ 1000 x 600 x 36 mm, 6 W  
127101059  
bez DPH s DPH  
**309,5 € 371,4 €**



■ 600 x 800 x 35 mm, 3 W  
127201669  
bez DPH s DPH  
**199,4 € 239,3 €**



■ 600 x 800 x 35 mm, 8 W  
127201679  
bez DPH s DPH  
**199,4 € 239,3 €**

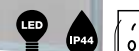

■ 1200 x 600 x 35 mm, 8 W  
127201719  
bez DPH s DPH  
**232,1 € 278,5 €**

# HOTELOVÉ VYBAVENIE/HOTEL EQUIPMENT

mosadz  
brass

chróm  
chrome

lesk  
shiny

mat  
matt

PVC

Fe



NOVINKA

- **Automatický dávkovač dezinfekcie**  
Automatic disinfectant dispenser, plastic  
140 x 235 x 107 mm, 1100 ml  
124109334  
124109344  
bez DPH      s DPH  
**86,5 €      103,8 €**



NOVINKA

- **Automatický dávkovač mydla**  
Soap dispenser, stainless steel  
132 x 224 x 162 mm, 300 ml  
137209155  
bez DPH      s DPH  
**60,0 €      72,0 €**



NOVINKA

- **Automatický dávkovač mydla alebo dezinfekcie, gel, nerez**  
Automatic disinfection or soap dispenser - gel, stainless steel  
142 x 268 x 102 mm, 1100 ml  
105109335  
bez DPH      s DPH  
**119,0 €      142,8 €**



NOVINKA

- **Automatický dávkovač penového mydla, nerez**  
Automatic soap dispenser - foam, stainless steel  
142 x 268 x 102 mm, 1100 ml  
105109345  
bez DPH      s DPH  
**120,0 €      144,0 €**



NOVINKA

- **Dávkovač tekutého mydla, nerez**  
Soap dispenser, stainless steel  
86 x 160 x 105 mm, 450 ml  
107109256  
bez DPH      s DPH  
**11,5 €      13,8 €**



NOVINKA

- **Dávkovač tekutého mydla, plast**  
Soap dispenser, plastic  
86 x 165 x 115 mm, 450 ml  
107109240  
bez DPH      s DPH  
**17,3 €      20,7 €**



NOVINKA

- **Dávkovač tekutého mydla, nerez**  
Soap dispenser, stainless steel  
110 x 235 x 82 mm, 800 ml  
106109085  
bez DPH      s DPH  
**39,0 €      46,8 €**



- **Dávkovač tekutého mydla, plast**  
Soap dispenser, plastic  
65 x 185 x 75 mm, 300 ml  
121209142 lesk/polished  
121209145 mat/matt  
bez DPH      s DPH  
**17,7 €      21,3 €**  
121209144 biely/white  
**15,0 €      18,0 €**



- **Dávkovač tekutého mydla dvojitý, plast**  
Double soap dispenser, plastic  
120 x 185 x 75 mm, 2 x 300 ml  
121209132 lesk/polished  
121209135 mat/matt  
bez DPH      s DPH  
**28,2 €      33,8 €**



- **Dávkovač tekutého mydla, plast**  
Soap dispenser, plastic  
115 x 245 x 110 mm, 1000 ml  
121209037 šedý/grey  
bez DPH      s DPH  
**29,9 €      35,9 €**  
121109036 biely/white  
**27,2 €      32,6 €**



- **Automatický dávkovač peny, plast biely**  
Automatic foam soap dispenser, white plastic  
135 x 275 x 120 mm, 1000 ml  
121209032  
bez DPH      s DPH  
**75,8 €      90,9 €**



- **Dávkovač tekutého mydla, plast**  
Soap dispenser, chromed plastic  
125 x 240 x 100 mm, 500 ml  
151109095  
bez DPH      s DPH  
**23,0 €      27,6 €**



- **Dávkovač tekutého mydla, nerez**  
Soap dispenser, stainless steel  
125 x 240 x 100, 350 ml  
151109015  
bez DPH      s DPH  
**40,6 €      48,8 €**



- **Automatický dávkovač mydla bezdotykový**  
Touch-free soap dispenser automatic  
100 x 220 x 113, 350 ml  
141109195  
bez DPH      s DPH  
**86,0 €      103,2 €**



- **Dávkovač tekutého mydla, nerez**  
Soap dispenser, stainless steel  
100 x 320 x 110 mm, 1100 ml  
123109013 lesk/polished  
bez DPH      s DPH  
**1 841 Kč      2 228 Kč**  
123209013 mat/matt  
**1 550 Kč      1 875 Kč**



- **Dávkovač tekutého mydla s pákou pre zdravotnícke zariadenia**  
Soap dispenser  
100 x 320 x 110 mm, 1100 ml  
101409171  
bez DPH      s DPH  
**190,0 €      228,0 €**



■ **Dávkoč tekutého mydla, lesk**  
Soap dispenser, polished  
100 x 150 x 105 mm, 400 ml  
106109091  
bez DPH      s DPH  
**23,4 €      28,0 €**



■ **Dávkoč tekutého mydla, nerez**  
Soap dispenser, stainless steel brushed  
98 x 150 x 95 mm, 500 ml  
105109025  
bez DPH      s DPH  
**25,0 €      30,0 €**

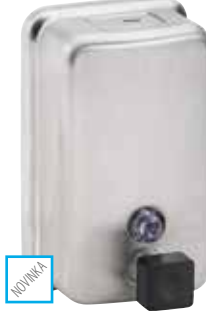

■ **Dávkoč tekutého mydla, nerez**  
Soap dispenser, stainless steel brushed  
108 x 180 x 97 mm, 850 ml  
105109035  
bez DPH      s DPH  
**27,0 €      32,4 €**



■ **Dávkoč tekutého mydla, brus**  
Soap dispenser, brushed  
125 x 210 x 110 mm, 1250 ml  
105109075  
bez DPH      s DPH  
**33,8 €      40,5 €**



■ **Dávkoč tekutého mydla, brus**  
Soap dispenser, brushed  
180 x 180 x 105 mm, 1500 ml  
105109205  
bez DPH      s DPH  
**42,7 €      51,2 €**



■ **Integrovaný dávkoč mydla, horné plnenie**  
Integrated soap dispenser, top filling  
60 x 292 x 130 mm, 300 ml  
152109222  
bez DPH      s DPH  
**35,4 €      42,5 €**



■ **Integrovaný dávkoč mydla, horné plnenie**  
Integrated soap dispenser, top filling  
62 x 287 x 125 mm, 470 ml  
136109012  
bez DPH      s DPH  
**24,7 €      29,7 €**



■ **Integrovaný dávkoč tekutého mydla a saponátu, horné plnenie**  
Built-in soap and detergent dispenser, top filling  
55 x 270 x 125 mm, 300 ml  
152109122 lesk/polished  
bez DPH      s DPH  
**32,3 €      38,8 €**  
152109125 mat/matt  
**34,4 €      41,2 €**



■ **Integrovaný dávkoč tekutého mydla a saponátu, horné plnenie**  
Built-in soap and detergent dispenser, top filling  
48 x 288 x 120 mm, 550 ml  
152109132 lesk/polished      s DPH **31,3 €      37,5 €**  
152109133 mat/matt      s DPH **33,3 €      40,0 €**



■ **Integrovaný dávkoč tekutého mydla a saponátu, horné plnenie**  
Built-in soap and detergent dispenser, top filling  
48 x 340 x 120 mm, 1100 ml  
152109142 lesk/polished      s DPH **34,6 €      41,5 €**  
152109143 mat/matt      s DPH **36,7 €      44,0 €**



■ **Integrovaný dávkoč tekutého mydla, nerez**  
Integrated soap dispenser, stainless steel  
240 x 140 x 150 mm, 1100 ml  
105109015  
bez DPH      s DPH  
**50,0 €      60,0 €**



■ **Zásobník na papierové vreckovky, chróm/plast**  
Paper tissue dispenser, chrome/plastic  
267 x 72 x 137 mm  
101303001  
bez DPH      s DPH  
**38,5 €      46,2 €**



■ **Zásobník na papierové vreckovky, na zabudovanie, nerez lesk**  
Paper tissue dispenser, stainless steel  
300 x 160 x 60 mm  
113103021  
bez DPH      s DPH  
**39,9 €      47,9 €**



■ **Integrovaný držiak pre zásobník na papierové vreckovky, lesk**  
Integrated holder for Paper tissue dispenser, polished  
200 x 120 x 110 mm  
134203022  
bez DPH      s DPH  
**26,4 €      31,7 €**



■ **Zásobník na papierové vreckovky, chróm/plast**  
Paper tissue dispenser, chrome/plastic  
115 x 130 x 115 mm  
101003021  
bez DPH      s DPH  
**20,6 €      24,7 €**

! Do vypredania zásob./Till sold out.

# HOTELOVÉ VYBAVENIE/HOTEL EQUIPMENT

mosadz  
brass

chróm  
chrome

lesk  
shiny

mat  
matt

PVC

Fe



NOVINKA

## ■ Zásobník na papierové vreckovky, nerez

Paper tissue dispenser, stainless steel

125 x 130 x 130 mm

105103071

bez DPH s DPH  
33,2 € 39,8 €



## ■ Zásobník na papierové vreckovky, nerez

Paper tissue dispenser, stainless steel

250 x 130 x 75 mm

|           |                      |               |
|-----------|----------------------|---------------|
|           | bez DPH              | s DPH         |
| 102303020 | čierna mat/black mat | 35,0 € 42,0 € |
| 102303021 | lesk/polished        | 41,3 € 49,5 € |
| 102303022 | bronz/bronze         | 37,0 € 44,4 € |
| 102303025 | mat/matt             | 45,0 € 54,0 € |



## ■ Zásobník hygienických vreciek (HygBag) na PVC vrecká vkládané, nerez

HygBag for PVC bags stacked, stainless steel

92 x 131 x 24 mm

|           |               |         |        |
|-----------|---------------|---------|--------|
|           |               | bez DPH | s DPH  |
| 101403131 | lesk/polished | 17,2 €  | 20,6 € |
| 101403135 | mat/matt      | 17,2 €  | 20,6 € |
| 101403134 | biela/white   | 11,6 €  | 14,0 € |



## ■ Zásobník hygienických vreciek (HygBag)

Hygienic bag dispenser, chromed plastic

100 x 135 x 25 mm

|           |                                      |       |
|-----------|--------------------------------------|-------|
| 101403032 | chróm, plast/chrome, plastic         |       |
| 101403030 | černý mat, plast/black matt, plastic |       |
|           | bez DPH                              | s DPH |
|           | 7,9 €                                | 9,4 € |



## ■ Zásobník hygienických vreciek

Hygienic paper bag dispenser

120 x 240 x 32 mm

|           |               |         |        |
|-----------|---------------|---------|--------|
|           |               | bez DPH | s DPH  |
| 101403091 | lesk/polished | 21,6 €  | 26,0 € |
| 101403095 | mat/matt      | 22,3 €  | 26,7 € |
| 101403094 | biela/white   | 16,4 €  | 19,7 € |



## ■ Zásobník hygienických vreciek (HygBag)

Hygienic bag dispenser, stainless steel

95 x 145 x 30 mm

|           |               |         |        |
|-----------|---------------|---------|--------|
|           |               | bez DPH | s DPH  |
| 101403031 | lesk/polished | 28,5 €  | 34,2 € |
| 101403035 | mat/matt      | 28,5 €  | 34,2 € |



## ■ Zásobník na papierové uteráky, nerez

Hand towel dispenser, stainless steel

lesk/polished

|           |                    |         |        |
|-----------|--------------------|---------|--------|
|           |                    | bez DPH | s DPH  |
| 113103031 | 285 x 265 x 110 mm | 53,4 €  | 64,0 € |
| 113103041 | 280 x 370 x 105 mm | 64,6 €  | 77,5 € |
|           | mat/matt           | bez DPH | s DPH  |
| 113103035 | 285 x 265 x 110 mm | 53,4 €  | 64,0 € |
| 113103045 | 280 x 370 x 105 mm | 64,6 €  | 77,5 € |



## ■ Zásobník na papierové uteráky skladané, biely plast

V-folded paper towel dispenser, white plastic

260 x 380 x 160 mm

|           |  |         |        |
|-----------|--|---------|--------|
| 121103106 |  | bez DPH | s DPH  |
|           |  | 27,2 €  | 32,6 € |



## ■ Zásobník na papierové uteráky, plast, biely

Paper towel dispenser, white plastic

260 x 315 x 105 mm

|           |  |         |        |
|-----------|--|---------|--------|
| 121103014 |  | bez DPH | s DPH  |
|           |  | 20,2 €  | 24,2 € |



## ■ Zásobník na papierové uteráky AUTOCUT, plast biely

Autocut paper dispenser, plastic, white

300 x 410 x 230 mm

|           |  |         |         |
|-----------|--|---------|---------|
| 121103116 |  | bez DPH | s DPH   |
|           |  | 135,0 € | 162,0 € |



## ■ Zásobník na papierové uteráky v roli, plast biely

Hand towel roll dispenser, plastic

240 x 325 x 240 mm

|           |  |         |        |
|-----------|--|---------|--------|
| 121403186 |  | bez DPH | s DPH  |
|           |  | 36,7 €  | 44,0 € |



■ **Zásobník na toaletný papier JUMBO, biely, plast**

Jumbo-roll Toilet Dispenser, white plastic

270 x 285 x 130 mm  
121112056

bez DPH s DPH  
**21,6 € 26,0 €**



■ **Zásobník na toaletný papier, nerez, zámok**

Jumbo-roll toilet paper dispenser, stainless steel

lesk/polished  
148212051 260 x 282 x 117 mm  
148312081 310 x 325 x 128 mm

bez DPH s DPH  
**54,3 € 65,1 €**  
mat/matt  
148212055 260 x 282 x 117 mm  
148312085 310 x 325 x 128 mm

bez DPH s DPH  
**54,3 € 65,1 €**  
bez DPH s DPH  
**64,3 € 77,1 €**  
bez DPH s DPH  
**54,3 € 65,1 €**  
bez DPH s DPH  
**64,3 € 77,1 €**



■ **Zásobník na toaletný papier nerez, zámok**

Jumbo-roll toilet paper dispenser, stainless steel

200 x 215 x 117 mm  
148112051 lesk/polished  
148112055 mat/matt

bez DPH s DPH  
**36,2 € 43,4 €**



NOVINKA

■ **Zásobník na hygienické ochrany WC, plast biely**

Toilet seat cover dispenser, white

435 x 285 x 50 mm  
121103265 šedý/gray

121103126 biely/white  
bez DPH s DPH  
**12,1 € 14,5 €**



■ **Držiak toaletného papiera, s krytom**

Paper holder with cover

140 x 80/190 x 100 mm  
105112315

bez DPH s DPH  
**14,5 € 17,4 €**



■ **Držiak toaletného papiera, dvojitý s krytom**

Double paper holder without cover

270 x 140 x 107 mm  
104112092

bez DPH s DPH  
**1 197 Kč 1 448 Kč**



■ **Držiak toaletného papiera, zabudovateľný, nerez lesk**

Integrated holder for toilet paper, polished

155 x 130 x 80 mm  
105112121

bez DPH s DPH  
**528 Kč 639 Kč**



■ **Držiak toaletného papiera, s krytom a policičkou pre mobil, nerez lesk**

Toilet paper holder with cover/mobile phone shelf

133 x 67 x 105 mm  
146212011

bez DPH s DPH  
**16,9 € 20,2 €**



NOVINKA

■ **Držiak toaletného papiera, s krytom a policičkou pre mobil, nerez lesk**

Toilet paper holder with mobile shelf

180 x 77 x 93 mm  
153312132

bez DPH s DPH  
**12,4 € 14,9 €**



■ **Držiak toaletného papiera, dvojitý bez krytu**

Double paper holder with cover

320 x 30 x 90 mm  
146212245

bez DPH s DPH  
**37,8 € 45,4 €**



■ **Integrovaný držiak toaletného papiera, lesk**

Integrated holder for toilet paper, polished

200 x 60 x 100 mm  
134103012

bez DPH s DPH  
**26,4 € 31,7 €**



!

■ **Osvěžovač vzduchu, plast, biely**

Perfume Dispenser, plastic, white

100 x 200 x 80 mm  
121134016

bez DPH s DPH  
**12,1 € 14,5 €**



■ **Šnúra na bielizeň, lesk**

Clothesline, polished

ø 95 x 45 mm, l = 2600 mm  
123126022

bez DPH s DPH  
**18,2 € 21,9 €**



■ **Trojháčik**

Triple hook

220 x 30 x 40 mm  
106105181

bez DPH s DPH  
**8,2 € 9,8 €**



■ **Otvárac fľaš, nerez lesk**

Bottle opener, stainless steel, polished

45 x 65 x 40 mm  
101832011

bez DPH s DPH  
**12,9 € 15,5 €**

# HOTELOVÉ VYBAVENIE/HOTEL EQUIPMENT

mosadz  
brass

chróm  
chrome

lesk  
shiny

mat  
matt

PVC

Fe



- **Odpadkový kôš s vrchnákom, stolový, 1,5 l, nerez /brús**  
Table bin with cover 1,5L, stainless steel brushed  
125 x 135 x 125 mm, 1,5 l  
137115205  
bez DPH s DPH  
**19,6 € 23,6 €**



- **Odpadkový kôš do izby lesk/mat**  
Room bin, polished/matt  
250 x 295 x 250 mm, 7,5 l  
150115161  
bez DPH s DPH  
**44,8 € 53,7 €**



- **Odpadkový kôš do izby, cierny**  
Room bin, black  
250 x 295 x 250 mm, 7,5 l  
150115151  
bez DPH s DPH  
**41,2 € 49,4 €**



- **Odpadkový kôš závesný, nerez**  
Wall mounted waste bin, stainless steel  
170 x 235 x 240 mm, 3 l  
125115051 lesk/polished  
125115055 lesk/polished  
bez DPH s DPH  
**19,1 € 22,9 €**



- **Odpadkový kôš bez vrchnáka, nerez**  
Waste bin without cover, stainless steel  
200 x 285 x 200 mm, 9 l  
115115031 lesk/polished  
115115035 lesk/polished  
bez DPH s DPH  
**26,4 € 31,7 €**



- **Gulatý odpadkový kôš, bronz**  
Trashbasket, bronze  
170 x 260 x 170 mm, 3 l  
104315023  
bez DPH s DPH  
**37,1 € 44,5 €**



- **Odpadkový kôš závesný**  
Waste bin, wall mounted  
190 x 265 x 90 mm, 5 l  
105115055  
bez DPH s DPH  
**45,0 € 54,0 €**



- **Odpadkový kôš „Soft Close“**  
Waste bin "Soft Close"  
200 x 280 x 205 mm, 5 l  
104315014 biely/white  
104315010 čierny/black  
bez DPH s DPH  
**16,8 € 20,1 €**



- **Odpadkový kôš bez vrchnáka, nerez/mat**  
Trash bin 9 l, stainless steel brushed  
240 x 340 x 240 mm, 9 l  
137115225  
bez DPH s DPH  
**54,4 € 65,3 €**



- **Odpadkový kôš „Soft Close“ s vrchnákom 15+15 l**  
Recycling trash Can double 15 l+15 l; stainless steel brushed; softclose  
400 x 490 x 320 mm, 15 l + 15 l  
137115165  
bez DPH s DPH  
**98,1 € 117,8 €**

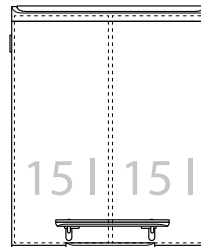

- **Odpadkový kôš, nerez lesk**  
Pedal bin, stainless steel, polished  
200 x 300 x 200 mm, 6 l  
125115071  
bez DPH s DPH  
**24,8 € 29,7 €**



- **Odpadkový kôš s voľným vhadením, 90 l, nerez /brús**  
Open trash can 90 l, stainless steel brushed  
448 x 750 x 448 mm, 90 l  
137115215  
bez DPH s DPH  
**199,7 € 239,7 €**



- **Popolník, lesk**  
Ashtray, polished  
100 x 120 x 35 mm  
106101015  
bez DPH s DPH  
**9,5 € 11,4 €**



- **Popolník vonkajší**  
Ashtray  
298x 800 x 298 mm  
101015150  
bez DPH s DPH  
**61,3 € 73,5 €**



- **Odpadkový kôš s popolníkom, lesk**  
Bin with ashtray, polished  
210 x 585 x 210 mm  
106315032  
bez DPH s DPH  
**45,4 € 54,5 €**





■ Hranatý odpadkový kôš závesný, hygienický  
Square waste bin, wall mounted  
200 x 285 x 200 mm, 6 l

|                         | bez DPH | s DPH  |
|-------------------------|---------|--------|
| 101915051 lesk/polished | 49,5 €  | 59,4 € |
| 101915054 biely/white   | 40,5 €  | 48,6 € |
| 101915055 mat/matt      | 44,4 €  | 53,3 € |



■ Hranatý odpadkový kôš na polozenie alebo zavesenie, nerez  
Square waste bin, free standing or hanging, stainless steel  
370 x 460 x 165 mm, 25 l

|                         | bez DPH | s DPH   |
|-------------------------|---------|---------|
| 125115041 lesk/polished | 96,7 €  | 116,0 € |
| 125115045 mat/matt      | 90,1 €  | 108,1 € |



■ Odpadkový kôš, nerez  
Pedal bin, stainless steel

| lesk/polished                      |  | bez DPH | s DPH   |
|------------------------------------|--|---------|---------|
| 104315022 170 x 260 x 170 mm, 3 l  |  | 12,7 €  | 15,3 €  |
| 104315012 200 x 280 x 200 mm, 5 l  |  | 16,4 €  | 19,7 €  |
| 104315032 250 x 400 x 250 mm, 12 l |  | 26,4 €  | 31,7 €  |
| 104315082 300 x 450 x 300 mm, 20 l |  | 54,0 €  | 64,8 €  |
| 104315092 300 x 650 x 300 mm, 30 l |  | 67,8 €  | 81,4 €  |
| 104315102 350 x 650 x 350 mm, 40 l |  | 90,5 €  | 108,6 € |
| mat/matt                           |  | bez DPH | s DPH   |
| 104315025 170 x 260 x 170 mm, 3 l  |  | 12,0 €  | 14,4 €  |
| 104315052 200 x 280 x 200 mm, 5 l  |  | 20,6 €  | 24,7 €  |



■ Hranatý odpadkový kôš na polozenie alebo zavesenie, nerez  
Wastebasket square, hanging

| lesk/polished                      |  | bez DPH | s DPH   |
|------------------------------------|--|---------|---------|
| 101915111 250 x 500 x 250 mm, 25 l |  | 102,6 € | 123,1 € |
| 101915121 300 x 600 x 250 mm, 45 l |  | 156,9 € | 188,2 € |
| 101915131 350 x 750 x 250 mm, 75 l |  | 249,2 € | 299,1 € |
| mat/matt                           |  | bez DPH | s DPH   |
| 101915115 250 x 500 x 250 mm, 25 l |  | 102,6 € | 123,1 € |
| 101915125 300 x 600 x 250 mm, 45 l |  | 156,9 € | 188,2 € |
| 101915135 350 x 750 x 250 mm, 75 l |  | 249,2 € | 299,1 € |

■ Konzola pre umývadlo  
Washbasin bracket

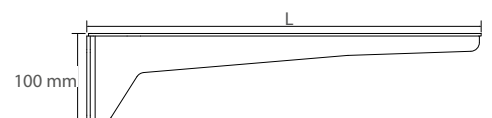

| Konzola            |           |   | Zatíženie/Weight | bez DPH | s DPH  |
|--------------------|-----------|---|------------------|---------|--------|
| Konzola L = 300 mm | 201541014 | Balenie 1 pár L+P<br>Package 1 pair L+P | 30 kg            | 35,0 €  | 42,0 € |
| Konzola L = 400 mm | 201541024 |   | 30 kg            | 38,0 €  | 45,6 € |
| Konzola L = 400 mm | 201541034 |   | 50 kg            | 40,0 €  | 48,0 € |
| Konzola L = 450 mm | 201541044 |   | 50 kg            | 43,0 €  | 51,6 € |

■ Konzola pre umývadlo, uzavretá  
Wash Basin Bracket rectangular

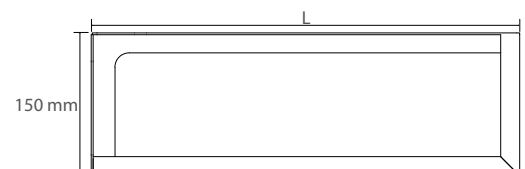

|                            | L      |           |             | bez DPH | s DPH  |
|----------------------------|--------|-----------|-------------|---------|--------|
| Nerez lesk/Stainless shine | 490 mm | 201541061 | Pravá/Right | 53,0 €  | 63,6 € |
| Nerez lesk/Stainless shine | 490 mm | 201541051 | Levá/Left   | 53,0 €  | 63,6 € |
| Nerez mat/Stainless matt   | 490 mm | 201541065 | Pravá/Right | 52,0 €  | 62,4 € |
| Nerez mat/Stainless matt   | 490 mm | 201541055 | Levá/Left   | 52,0 €  | 62,4 € |
| Fe biela/Fe white          | 490 mm | 201541064 | Pravá/Right | 30,0 €  | 36,0 € |
| Fe biela/Fe white          | 490 mm | 201541054 | Levá/Left   | 30,0 €  | 36,0 € |

# HOTELOVÉ VYBAVENIE/HOTEL EQUIPMENT

mosadz  
brass

chróm  
chrome

lesk  
shiny

mat  
matt

PVC

Fe



## ■ Dverová zarážka na zem

Door stop on floor  
33 x 30 x 33 mm

|           |                      |         |        |       |        |
|-----------|----------------------|---------|--------|-------|--------|
| 101218012 | chróm/chrome         | bez DPH | 6,8 €  | s DPH | 8,2 €  |
| 101218015 | nerez/stainless matt | bez DPH | 7,2 €  | s DPH | 8,6 €  |
| 101218017 | mosadz/brass         | bez DPH | 10,6 € | s DPH | 12,7 € |



## ■ Dverová zarážka na stenu

Door stop on wall  
18 x 18 x 80 mm

|           |                      |         |        |       |        |
|-----------|----------------------|---------|--------|-------|--------|
| 101218022 | chróm/chrome         | bez DPH | 11,3 € | s DPH | 13,5 € |
| 101218025 | nerez/stainless matt | bez DPH | 8,9 €  | s DPH | 10,7 € |
| 101218027 | mosadz/brass         | bez DPH | 11,3 € | s DPH | 13,5 € |



## ■ Zásobník na papierové uteráky s odpadkovým košom, nástenný

Hand towel dispenser with garbage bin, hanging, polished

310 x 1225 x 155 mm  
113103052 lesk/polished  
113103055 mat/matt

|         |         |
|---------|---------|
| bez DPH | s DPH   |
| 576,1 € | 691,3 € |



## ■ Kúpeľňový vozík

Trolley  
450 x 820 x 300 mm  
104832012

|         |         |
|---------|---------|
| bez DPH | s DPH   |
| 178,7 € | 214,5 € |



## ■ 5-poschodová polička na uteráky, lesk

Penta towel rack, polished  
150 x 265 x 120 mm  
101302182

|         |        |
|---------|--------|
| bez DPH | s DPH  |
| 32,7 €  | 39,2 € |



## ■ Automatický sušič rúk, nerez

Automatic hand dryer, stainless steel  
170 x 255 x 100 mm, 1000 W  
924224150

|          |          |
|----------|----------|
| bez DPH  | s DPH    |
| 135,0 Kč | 162,0 Kč |



## ■ Automatický sušič rúk, nerez

Automatic hand dryer, stainless steel  
170 x 255 x 100 mm, 1000 W  
924224155

|          |          |
|----------|----------|
| bez DPH  | s DPH    |
| 135,0 Kč | 162,0 Kč |



## ■ Bezdotykový sušič rúk, s HEPA filtrom; biely plast

Hand dryer with HEPA filter, plastic, white color  
298 x 669 x 184 mm, 1850 W  
924224104

|         |         |
|---------|---------|
| bez DPH | s DPH   |
| 582,0 € | 698,4 € |



## ■ Bezdotykový sušič rúk – 2300W, LED light, nerez lesk

Automatic hand dryer, stainless steel  
270 x 237 x 208 mm, 2300 W  
924224141

|         |         |
|---------|---------|
| bez DPH | s DPH   |
| 225,0 € | 270,0 € |



## ■ Automatický osušič rukou, nerez

Automatic hand dryer, stainless steel  
270 x 240 x 220 mm, 2500 W  
945224061 lesk/polished

|                    |         |
|--------------------|---------|
| bez DPH            | s DPH   |
| 280,3 €            | 336,3 € |
| 106224015 mat/matt |         |
| bez DPH            | s DPH   |
| 273,0 €            | 327,6 € |



## ■ Bezdotykový sušič rúk – 1350W, LED light, nerez lesk

Automatic hand dryer, stainless steel  
173 x 255 x 150 mm, 1350 W  
924224131 lesk/polished

|                    |         |
|--------------------|---------|
| 924224135 mat/matt |         |
| bez DPH            | s DPH   |
| 165,0 €            | 198,0 € |



## ■ Bezdotykový sušič rúk – 1800W, LED light, nerez lesk

Automatic hand dryer, stainless steel  
270 x 237 x 208 mm, 1800 W  
924224121

|         |         |
|---------|---------|
| bez DPH | s DPH   |
| 222,5 € | 267,0 € |



## ■ Bezdotykový sušič rúk – 1000W, HEPA filtr, LED light, nerez lesk

Automatic hand dryer, stainless steel  
Händetrockner, Edelstahl  
286 x 321 x 99 mm, 1000 W  
924224111

|         |         |
|---------|---------|
| bez DPH | s DPH   |
| 210,8 € | 253,0 € |



## ■ Bezdotykový sušič rúk, plast biely

Hand dryer, plastic white  
240 x 240 x 230 mm, 1800 W  
945224016

|         |         |
|---------|---------|
| bez DPH | s DPH   |
| 86,0 €  | 103,2 € |



■ **Fén bez držiaka**  
Hair dryer without holder  
75 x 270 x 190 mm, 1 400 W  
945433084 **bílý/white**  
945433088 **černý/black**  
bez DPH s DPH  
**34,4 € 41,2 €**



■ **Fén s držiakom – SET**  
Hair dryer with holder  
75 x 270 x 190 mm, 1 400 W  
999433084 **bílý/white**  
999433088 **černý/black**  
bez DPH s DPH  
**50,6 € 60,7 €**



■ **Fén s držiakom, pištoľový**  
Hair dryer with holder  
110 x 270 x 140 mm, 1 400 W  
945533074  
bez DPH s DPH  
**40,5 € 48,6 €**



■ **Fén s držiakom**  
Hair dryer with holder  
110 x 270 x 310 mm, 1 400 W  
945233066  
bez DPH s DPH  
**45,0 € 54,0 €**



■ **Fén s držiakom a zástrčkou**  
Hair dryer with holder and socket  
100 x 270 x 310 mm, 1 400 W  
945233054 **bílý/white**  
945233058 **černý/black**  
bez DPH s DPH  
**52,3 € 62,8 €**



■ **Hotelový fén**  
Hotel hair dryer  
180 x 370 x 120 mm  
945133016  
bez DPH s DPH  
**76,7 € 92,1 €**



■ **Držiak fénu, lesk**  
Hair dryer holder, polished  
80 x 55 x 100 mm  
101117012  
bez DPH s DPH  
**17,2 € 20,6 €**



■ **Držiak fénu, špirálový**  
Hair dryer holder, spiral  
100 x 185 x 125 mm  
132117022 **hranatý/square**  
bez DPH s DPH  
**20,6 € 24,7 €**  
104117022 **kulatý/round**  
**18,5 € 22,2 €**



■ **Sklopné sprchové sedátko, nerez**  
Reversible shower seat, stainless steel  
462 x 120 x 450 mm  
347125011  
bez DPH s DPH  
**178,3 € 214,0 €**



■ **Sklopné sprchové sedátko s opornou nohou**  
Reversible shower seat with supporting leg  
350 x 433 x 365 mm  
205125035  
ez DPH s DPH  
**210,0 € 252,0 €**



■ **Sklopné sprchové sedátko s opornou nohou**  
Reversible shower seat with supporting leg  
462 x 120 x 450 mm  
301102181 **lesk/polished**  
bez DPH s DPH  
**137,1 € 164,5 €**  
301102182 **mat/matt**  
bez DPH s DPH  
**143,9 € 172,7 €**



■ **Sedadlo sklopné transparentné, lesk**  
Shower seat, transparent, polished  
380 x 460 x 555 mm  
326325056  
bez DPH s DPH  
**85,7 € 102,8 €**



■ **Držadlo na sklenené dvere**  
Handle for glass door  
445 x 55 x 125 mm  
247131013  
bez DPH s DPH  
**56,0 € 67,2 €**



■ **Držadlo pevné, lesk**  
Bath grab bar, polished  
340 x 60 x 80 mm  
106107011  
bez DPH s DPH  
**15,7 € 18,8 €**



■ **Držadlo lomené, lesk**  
Bath grab bar angled, polished  
425 x 250 x 80 mm  
106107021  
bez DPH s DPH  
**17,8 € 21,4 €**



■ **Držadlo lomené s mydlovničkou lesk**  
Bath grab bar angled with soap basket, polished  
455 x 250 x 120 mm  
106107031  
bez DPH s DPH  
**28,5 € 34,2 €**

# HOTELOVÉ VYBAVENIE/HOTEL EQUIPMENT

mosadz  
brass

chróm  
chrome

lesk  
shiny

mat  
matt

PVC

Fe



- **Prebaľovací pult, nástenný, plast**  
Babychanging station  
550 x 900 x 140 mm  
138235026  
bez DPH s DPH  
**291,7 € 350,0 €**



- **Prebaľovacia miestnosť**  
Baby nursery room  
120 x 120 x 2 mm  
111022062 lesk/polished  
111022065 mat/matt  
bez DPH s DPH  
**11,3 € 13,5 €**



- **Fajčenie povolené**  
Smoking  
120 x 140 x 2 mm  
111022012 lesk/polished  
111022015 mat/matt  
bez DPH s DPH  
**13,3 € 16,0 €**



- **Zákaz fajčenia**  
No smoking  
120 x 140 x 2 mm  
111022052 lesk/polished  
111022055 mat/matt  
bez DPH s DPH  
**13,3 € 16,0 €**



- **WC páni**  
Gentlemen toilet  
120 x 130 x 2 mm  
111022032 lesk/polished  
111022035 mat/matt  
bez DPH s DPH  
**12,7 € 15,3 €**



- **WC dámy**  
Ladies toilet  
120 x 130 x 2 mm  
111022042 lesk/polished  
111022045 mat/matt  
bez DPH s DPH  
**12,7 € 15,3 €**



- **WC vozíčkar**  
Disabled toilets  
120 x 130 x 2 mm  
111022022 lesk/polished  
111022025 mat/matt  
bez DPH s DPH  
**12,7 € 15,3 €**



- **WC**  
WC  
120 x 120 x 2 mm  
111022082 lesk/polished  
111022085 mat/matt  
bez DPH s DPH  
**12,7 € 15,3 €**



- **Sprcha**  
Showers  
120 x 120 x 2 mm  
111022072 lesk/polished  
111022075 mat/matt  
bez DPH s DPH  
**15,4 € 18,5 €**



- **Upratovacia miestnosť**  
Cleaning room  
120 x 120 x 2 mm  
111022092 lesk/polished  
111022095 mat/matt  
bez DPH s DPH  
**11,3 € 13,5 €**



- **Zrkadlová skrinka s osvetlením**  
Bathroom mirror cabinet with LED light  
380 x 610 x 120 mm  
127401729  
bez DPH s DPH  
**274,4 € 329,3 €**



- **Zrkadlo nerez SUPER lesk na nalepenie**  
Mirror – stainless SUPER mirror  
600 x 800 mm  
101301652  
bez DPH s DPH  
**103,2 € 123,9 €**



- **Zrkadlo s LED osvetleným rámom**  
Mirror with LED illuminated frame  
1200 x 600 x 35 mm, 8 W  
127201719  
bez DPH s DPH  
**232,1 € 278,5 €**

# SPRCHOVÝ PROGRAM / SHOWER EQUIPMENT

**BEMETA®**

mosadz  
brass

nerez  
stainless

chróm  
chrome

PVC



- **Nožná podpera**  
Footrest  
100 x 60 x 165 mm  
203125084  
bez DPH s DPH  
**42,9 € 51,4 €**



- **Sprchové sedadlo**  
Shower seat  
350 x 70 x 340 mm  
203125064  
bez DPH s DPH  
**67,1 € 80,6 €**



- **Sprchové sedadlo**  
Shower seat  
350 x 70 x 340 mm  
203125074  
bez DPH s DPH  
**98,8 € 118,6 €**



- **Sprchová tyč s jazdcom, pochrómovaná mosadz**  
Shower rail with holder, chromed brass  
104114112 90 x 650 x 70 mm **55,4 € 66,4 €**  
104114122 90 x 905 x 70 mm **64,6 € 77,5 €**



- **Držadlo na sklenené dvere**  
Handle for glass door  
445 x 55 x 125 mm  
247131013  
bez DPH s DPH  
**56,0 € 67,2 €**



- **Sprchové sedadlo**  
Shower seat  
350 x 70 x 340 mm  
203025074  
bez DPH s DPH  
**98,8 Kč 118,6 Kč**



























- **Tyč sprchového závesu, nerez lesk\***  
Shower curtain holder, corner model, stainless steel, polished\*  
101114361 ø 25 mm, 900 x 55 x 55 mm **36,4 € 43,6 €**  
101120012 ø 25 mm, 1 000 x 55 x 55 mm **38,1 € 45,7 €**  
101120022 ø 25 mm, 1 500 x 55 x 55 mm **45,5 € 54,5 €**  
101120032 ø 25 mm, 2 000 x 55 x 55 mm **53,3 € 64,0 €**





























- **Tyč sprchového závesu rohová, nerez lesk\***  
Shower curtain holder, corner model, stainless steel, polished\*  
101120042 ø 25 mm, 900 x 500 x 900 mm **75,7 € 90,9 €**  
101120052 ø 25 mm, 1 400 x 500 x 1 400 mm **100,1 € 120,1 €**





















\*Tyče dodávame bez sprchového závesu./The rods are supplied without a shower curtain.

# NÁHRADNÉ DIELY/SPARE PARTS

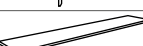



















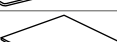

| Produkt<br>Product                               | Náhradný diel<br>Spare part   | Cena €<br>bez DPH<br>Price | Cena €<br>vč. DPH<br>Price | Objednávkové číslo<br>Ordering number |
|--|---|----------------------------|----------------------------|---------------------------------------|
| <b>GAMMA</b>                                     |   |                            |                            |                                       |
| 145713314<br>145513092<br>145413092<br>145613310 |  Náhradná WC kefa s rukoväťou<br>Spare WC brush with handle                                | 18,8                       | 22,6                       | 131567458                             |
| 145713324  |  Náhradná WC kefa s rukoväťou<br>Spare WC brush with handle                                | 8,0                        | 9,6                        | 131567459                             |
| 145613320  |  Náhradná WC kefa s rukoväťou<br>Spare WC brush with handle                                | 8,0                        | 9,6                        | 131567474                             |
| 145413092<br>145613310<br>145513092<br>145713314 |  Náhradná WC kefa bez rukoväte<br>Spare WC brush without handle                            | 4,0                        | 4,8                        | 131567008                             |
| 145413092<br>145613310<br>145513092<br>145713314 |  Náhradná WC kefa bez rukoväte<br>Spare WC brush without handle                            | 4,0                        | 4,8                        | 131567008c                            |
| 145609310<br>145709314                           |  Náhradná pumpička k dávkovaču mydla<br>Spare pump complete, chrome                        | 18,8                       | 22,5                       | 131567456                             |
| <b>VISTA</b>                                     |   |                            |                            |                                       |
| 120113316-xxx                                    |  Náhradná WC kefa bez rukoväte<br>Spare WC brush without handle                            | 4,0                        | 4,8                        | 131567464                             |
| 120113316-xxx                                    |  Náhradná WC kefa bez rukoväte<br>Spare WC brush without handle                           | 4,0                        | 4,8                        | 131567463                             |
| 120109016-xxx                                    |  Náhradná pumpička k dávkovaču mydla<br>Spare pump complete, chrome                       | 6,0                        | 7,2                        | 131567473                             |
| <b>GALLA</b>                                     |   |                            |                            |                                       |
| 108113010  |  Náhradná WC kefa s rukoväťou<br>Spare WC brush with handle                              | 8,8                        | 10,6                       | 131567404                             |
| 108113010  |  Náhradná WC kefa bez rukoväte<br>Spare WC brush without handle                          | 4,0                        | 4,8                        | 131567008c                            |
| 108108020  |  Náhradná miska pre mydelničku, polyresin<br>Glass soap dish, polyresin                  | 9,3                        | 11,2                       | 131567470                             |
| 108110010  |  Náhradný pohár pre držiak zubných kef, polyresin<br>Glass cup, polyresin                | 9,3                        | 11,2                       | 131567465                             |
| 108109010  |  Náhradná pumpička s krúžkom<br>Spare pump complete, with cover                          | 20,0                       | 24,0                       | 131567466                             |
| <b>WHITE</b>                                     |   |                            |                            |                                       |
| 104913094<br>104113014                           |  Náhradná WC kefa s rukoväťou<br>Spare WC brush with handle                              | 8,8                        | 10,6                       | 131567162                             |
| 104913094<br>102313064<br>104113014              |  Náhradná WC kefa bez rukoväte<br>Spare WC brush without handle                          | 4,0                        | 4,8                        | 131567008                             |
| 104913094<br>102313064<br>104113014              |  Náhradná WC kefa bez rukoväte<br>Spare WC brush without handle                          | 4,0                        | 4,8                        | 131567008c                            |
| 104113014  |  Náhradná sklenená miska na WC kefu, mliečne sklo<br>Glass dish for WC brush, frosted    | 5,4                        | 6,5                        | 131567003                             |
| 104108044  |  Náhradná miska pre mydelničku, mliečne sklo<br>Soap dish, ceramics                      | 3,8                        | 4,5                        | 131567002m                            |
| 104110014  |  Náhradný pohár, mliečne sklo<br>Glass cup, frosted                                      | 3,0                        | 3,6                        | 131567001m                            |
| 104109014  |  Náhradné sklo pre dávkovač, mliečne sklo<br>Glass for soap dispenser, frosted           | 21,0                       | 25,2                       | 131567243                             |
| 104109104  |  Náhradné sklo pre dávkovač MINI, mliečne sklo<br>Glass for soap dispenser MINI, frosted | 5,3                        | 6,3                        | 131567111                             |
| 104109014<br>104109104                           |  Náhradná pumpička k dávkovaču<br>Spare pump complete, white                             | 13,2                       | 15,9                       | 131567409                             |
| 104102044  |  Náhradné sklo k poličke, mliečne sklo<br>Glass for shelf, frosted                       | 10,1                       | 12,1                       | 131567429                             |

| Produkt<br>Product                  | Náhradný diel<br>Spare part   | Cena €<br>bez DPH<br>Price | Cena €<br>vč. DPH<br>Price | Objednávkové číslo<br>Ordering number |
|-------------------------------------|---|----------------------------|----------------------------|---------------------------------------|
| <b>NERO</b>                         |   |                            |                            |                                       |
| 135013010                           |  Náhradná WC kefa s rukoväťou<br>Spare WC brush with handle                                | 10,3                       | 12,3                       | 131567365                             |
| 135913090<br>135013010              |  Náhradná WC kefa bez rukoväte<br>Spare WC brush without handle                            | 2,8                        | 3,4                        | 131567384c                            |
| 135013010                           |  Náhradná sklenená miska na WC kefu, mliečne sklo<br>Glass dish for WC brush, frosted      | 8,7                        | 10,4                       | 131567253                             |
| 135008020                           |  Náhradná miska pre mydelničku, mliečne sklo<br>Soap dish, ceramics                        | 5,3                        | 6,4                        | 131567250                             |
| 135011010                           |  Náhradný pohár, mliečne sklo<br>Glass cup, frosted  | 5,3                        | 6,4                        | 131567249                             |
| 135009040                           |  Náhradné sklo pre dávkovač, mliečne sklo<br>Glass for soap dispenser, frosted             | 8,0                        | 9,6                        | 131567251                             |
| 135009040                           |  Náhradná pumpička k dávkovaču mydla<br>Spare pump complete, chrome                        | 13,2                       | 15,9                       | 131567239                             |
| 135002240                           |  Náhradné sklo k poličke, mliečne sklo<br>Glass for shelf, frosted                         | 10,0                       | 12,0                       | 131567254                             |
| <b>DARK</b>                         |   |                            |                            |                                       |
| 104913090                           |  Náhradná WC kefa s rukoväťou<br>Spare WC brush with handle                                | 10,2                       | 12,3                       | 131567446                             |
| 104113010                           |  Náhradná WC kefa s rukoväťou<br>Spare WC brush with handle                               | 8,8                        | 10,6                       | 131567404                             |
| 102313060<br>104113010<br>104913090 |  Náhradná WC kefa bez rukoväte<br>Spare WC brush without handle                          | 4,0                        | 4,8                        | 131567008c                            |
| 104113010                           |  Náhradná sklenená miska na WC kefu, mliečne sklo<br>Glass dish for WC brush, frosted    | 5,4                        | 6,5                        | 131567003                             |
| 104108040                           |  Náhradná miska pre mydelničku, mliečne sklo<br>Soap dish, ceramics                      | 3,8                        | 4,5                        | 131567002m                            |
| 104110010                           |  Náhradný pohár, mliečne sklo<br>Glass cup, frosted                                      | 3,0                        | 3,6                        | 131567001m                            |
| 104109010                           |  Náhradné sklo pre dávkovač, mliečne sklo<br>Glass for soap dispenser, frosted           | 21,0                       | 25,2                       | 131567243                             |
| 104109100                           |  Náhradné sklo pre dávkovač MINI, mliečne sklo<br>Glass for soap dispenser MINI, frosted | 5,3                        | 6,3                        | 131567111                             |
| 104109010<br>104109100              |  Náhradná pumpička k dávkovaču mydla<br>Spare pump complete, chrome                      | 13,2                       | 15,8                       | 131567239                             |
| 104102040                           |  Náhradné sklo k poličke, mliečne sklo<br>Glass for shelf, frosted                       | 7,3                        | 8,7                        | 131567011                             |
| <b>TASI</b>                         |   |                            |                            |                                       |
| 154113012                           |  Náhradná WC kefa s rukoväťou<br>Spare WC brush with handle                              | 7,9                        | 9,4                        | 131567009c                            |
| 154113012                           |  Náhradná WC kefa bez rukoväte<br>Spare WC brush without handle                          | 4,0                        | 4,8                        | 131567008                             |
| 154113012                           |  Náhradná WC kefa bez rukoväte<br>Spare WC brush without handle                          | 4,0                        | 4,8                        | 131567008c                            |
| 154113012                           |  Náhradná sklenená miska na WC kefu, mliečne sklo<br>Glass dish for WC brush, frosted    | 5,4                        | 6,5                        | 131567003                             |
| 154108022                           |  Náhradná miska pre mydelničku, mliečne sklo<br>Soap dish, ceramics                      | 3,8                        | 4,5                        | 131567002m                            |
| 154110012                           |  Náhradný pohár, mliečne sklo<br>Glass cup, frosted                                      | 3,0                        | 3,6                        | 131567001m                            |
| 154109042                           |  Náhradné sklo pre dávkovač, mliečne sklo<br>Glass for soap dispenser, frosted           | 21,0                       | 25,2                       | 131567243                             |
| 154109042                           |  Náhradná pumpička k dávkovaču mydla<br>Spare pump complete, chrome                      | 13,8                       | 16,5                       | 131567204                             |





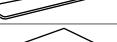











# NÁHRADNÉ DIELY/SPARE PARTS





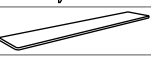























| Produkt<br>Product   | Náhradný diel<br>Spare part   | Cena €<br>bez DPH<br>Price | Cena €<br>vč. DPH<br>Price | Objednávkové číslo<br>Ordering number |
|--|---|----------------------------|----------------------------|---------------------------------------|
| <b>KERA</b>  |   |                            |                            |                                       |
| 144713017  |  Náhradná WC kefa s rukoväťou<br>Spare WC brush with handle                                | 12,3                       | 14,8                       | 131567436                             |
| 144713017  |  Náhradná WC kefa bez rukoväte<br>Spare WC brush without handle                            | 4,0                        | 4,8                        | 131567008                             |
| 144713017  |  Náhradná sklenená miska na WC kefu, keramika<br>Glass dish for WC brush, frosted          | 5,4                        | 6,5                        | 131567095                             |
| 144708027  |  Náhradná miska pre mydelničku, keramika<br>Soap dish, ceramics                            | 5,0                        | 6,0                        | 131567094                             |
| 144710017<br>144710027   |  Náhradný pohár, keramika<br>Glass, ceramics   | 5,0                        | 6,0                        | 131567093                             |
| 144709017  |  Náhradné sklo pre dávkovač, keramika<br>Glass for soap dispenser, ceramics                | 7,5                        | 9,0                        | 131567068                             |
| 144709017  |  Náhradná pumpička k dávkovaču mydla<br>Spare pump complete, chrome                        | 12,1                       | 14,5                       | 131567273                             |
| <b>SOLO</b>  |   |                            |                            |                                       |
| 139113142  |  Náhradná WC kefa s rukoväťou<br>Spare WC brush with handle                                | 6,4                        | 7,6                        | 131567417                             |
| 139113142  |  Náhradná WC kefa bez rukoväte<br>Spare WC brush without handle                            | 95,-                       | 115,-                      | 131567049                             |
| 139113142  |  Náhradná sklenená miska na WC kefu, mliečne sklo<br>Glass dish for WC brush, frosted      | 10,4                       | 12,5                       | 131567123                             |
| 139108032  |  Náhradná miska pre mydelničku, mliečne sklo<br>Soap dish, ceramics                       | 5,3                        | 6,4                        | 131567250                             |
| 139110012  |  Náhradný pohár, mliečne sklo<br>Glass cup, frosted                                      | 5,3                        | 6,4                        | 131567249                             |
| 139109042  |  Náhradné sklo pre dávkovač MINI, mliečne sklo<br>Glass for soap dispenser MINI, frosted | 8,0                        | 9,6                        | 131567251                             |
| 139109042  |  Náhradná pumpička k dávkovaču mydla<br>Spare pump complete, chrome                      | 13,2                       | 15,9                       | 131567063                             |
| 139102312  |  Náhradné sklo k poličke, mliečne sklo<br>Glass for shelf, frosted                       |                            |                            | 131567104                             |
| <b>OMEGA</b>   |   |                            |                            |                                       |
| 104113012<br>104113102<br>104836012<br>104913092<br>104913112<br>104913122<br>104913152  |  Náhradná WC kefa s rukoväťou<br>Spare WC brush with handle                              | 7,9                        | 9,4                        | 131567009                             |
| 104113107<br>104113017<br>104836012<br>104913092<br>104913117<br>104913122<br>104913152  |  Náhradná WC kefa s rukoväťou<br>Spare WC brush with handle                              | 7,9                        | 9,4                        | 131567009c                            |
| 102313066  |  Náhradná WC kefa s rukoväťou a krytkou<br>Spare WC brush incl. handle with vessel cover | 16,8                       | 20,2                       | 131567054b                            |
| 102313067  |  Náhradná WC kefa s rukoväťou a krytkou<br>Spare WC brush incl. handle with vessel cover | 16,8                       | 20,2                       | 131567054                             |
| 102313057W<br>102313066<br>104113012<br>104113107<br>104836012<br>104913090<br>104913092W<br>104913112<br>104913117<br>104913122W<br>104913152 |  Náhradná WC kefa bez rukoväte<br>Spare WC brush without handle                          | 4,0                        | 4,8                        | 131567008                             |

























| Produkt<br>Product   | Náhradný diel<br>Spare part   | Cena €<br>bez DPH<br>Price | Cena €<br>vč. DPH<br>Price | Objednávkové číslo<br>Ordering number |
|--|---|----------------------------|----------------------------|---------------------------------------|
| 102313066<br>102313057W<br>104113012<br>104113107<br>104836012<br>104913090<br>104913092W<br>104913112<br>104913117<br>104913122W<br>104913152 |  Náhradná WC kefa bez rukoväte<br>Spare WC brush without handle  | 4,0                        | 4,8                        | 131567008c                            |
| 104113102<br>104113107<br>104113012<br>104113017   |  Náhradná sklenená miska na WC kefu, mliečne sklo<br>Glass dish for WC brush, frosted                  | 5,4                        | 6,5                        | 131567003                             |
| 104108042<br>138108191   |  Náhradná miska pre mydelničku, mliečne sklo<br>Soap dish, ceramics                                    | 3,8                        | 4,5                        | 131567002m                            |
| 104110012<br>104110022<br>104110042<br>138110061   |  Náhradný pohár, mliečne sklo<br>Glass cup, frosted  | 3,0                        | 3,6                        | 131567001m                            |
| 104109017<br>104019012   |  Náhradné sklo pre dávkovač, mliečne sklo<br>Glass for soap dispenser, frosted                         | 21,0                       | 25,2                       | 131567243                             |
| 104109102<br>104109182   |  Náhradné sklo pre dávkovač MINI, mliečne sklo<br>Glass for soap dispenser MINI, frosted               | 5,3                        | 6,3                        | 131567111                             |
| 138709041<br>138109161   |  Náhradné sklo pre dávkovač MINI vč. pumpičky, mliečne sklo<br>Glass for soap dispenser MINI with pump | 5,3                        | 6,3                        | 131567147                             |
| 104019012<br>104109012<br>104109017<br>104109102<br>104109182  |  Náhradná pumpička k dávkovaču mydla<br>Spare pump complete, chrome                                  | 13,8                       | 16,5                       | 131567204                             |
| 104609172<br>138109161<br>138709041  |  Náhradná pumpička k dávkovaču mydla<br>Spare pump   | 5,3                        | 6,3                        | 131567007                             |
| 104122042  |  Náhradné sklo k poličke, mliečne sklo<br>Glass for shelf, frosted                                   | 5,4                        | 6,5                        | 131567117                             |
| 104102042  |  Náhradné sklo k poličke, mliečne sklo<br>Glass for shelf, frosted                                   | 7,3                        | 8,7                        | 131567011                             |
| 104102012  |  Náhradné sklo krovej poličke, mliečne sklo<br>Glass for corner shelf, frosted                       | 6,5                        | 7,8                        | 131567047                             |
| <b>BETA</b>  |   |                            |                            |                                       |
| 132113012  |  Náhradná WC kefa s rukoväťou<br>Spare WC brush with handle  | 7,9                        | 9,4                        | 131567009                             |
| 132113017  |  Náhradná WC kefa s rukoväťou<br>Spare WC brush with handle  | 7,9                        | 9,4                        | 131567009c                            |
| 132113012  |  Náhradná WC kefa bez rukoväte<br>Spare WC brush without handle                                      | 4,0                        | 4,8                        | 131567008                             |
| 132113017  |  Náhradná WC kefa bez rukoväte<br>Spare WC brush without handle                                      | 4,0                        | 4,8                        | 131567008c                            |
| 132108042  |  Náhradná miska pre mydelničku, mliečne sklo<br>Soap dish, ceramics                                  | 3,8                        | 4,5                        | 131567002m                            |
| 132110012<br>132110022<br>132110042  |  Náhradný pohár, mliečne sklo<br>Glass cup, frosted  | 3,0                        | 3,6                        | 131567001m                            |
| 132109017  |  Náhradné sklo pre dávkovač, mliečne sklo<br>Glass for soap dispenser, frosted                       | 21,0                       | 25,2                       | 131567243                             |
| 132109102<br>132109182   |  Náhradné sklo pre dávkovač MINI, mliečne sklo<br>Glass for soap dispenser MINI, frosted             | 5,3                        | 6,3                        | 131567111                             |
| 132122042  |  Náhradné sklo k poličke, mliečne sklo<br>Glass for shelf, frosted                                   | 5,4                        | 6,5                        | 131567117                             |
| 132102042  |  Náhradné sklo k poličke, mliečne sklo<br>Glass for shelf, frosted                                   | 7,3                        | 8,7                        | 131567011                             |
| 132102012  |  Náhradné sklo na rohovou poličku, mliečne sklo<br>Glass for corner shelf, frosted                   | 6,5                        | 7,8                        | 131567047                             |
| 132109017<br>132109102<br>132109182  |  Náhradná pumpička k dávkovaču mydla<br>Spare pump complete, chrome                                  | 13,8                       | 16,5                       | 131567204                             |























# NÁHRADNÉ DIELY/SPARE PARTS

| Produkt<br>Product  | Náhradný diel<br>Spare part   | Cena €<br>bez DPH<br>Price | Cena €<br>vč. DPH<br>Price | Objednávkové číslo<br>Ordering number |
|---|---|----------------------------|----------------------------|---------------------------------------|
| <b>NEO</b>  |   |                            |                            |                                       |
| 102313065   |  Náhradná WC kefa s rukoväťou a krytkou<br>Spare WC brush incl. handle with vessel cover   | 17,8                       | 21,4                       | 131567120b                            |
| 102313069   |  Náhradná WC kefa s rukoväťou a krytkou<br>Spare WC brush incl. handle with vessel cover   | 17,8                       | 21,4                       | 131567120                             |
| 102313075<br>102313079<br>104113015<br>104113019<br>104113105   |  Náhradná WC kefa s rukoväťou<br>Spare WC brush with handle                                | 8,3                        | 9,9                        | 131567031a                            |
| 102313079<br>102313075<br>104113015<br>104113019<br>104113109   |  Náhradná WC kefa s rukoväťou<br>Spare WC brush with handle                                | 8,3                        | 9,9                        | 131567031c                            |
| 102313055<br>102313059<br>102313065<br>102313067<br>102313069<br>102313079<br>102313075<br>104113015<br>104113019<br>104113105<br>104113109 |  Náhradná WC kefa bez rukoväte<br>Spare WC brush without handle                            | 4,0                        | 4,8                        | 131567008                             |
| 102313055<br>102313059<br>102313065<br>102313067<br>102313069<br>102313075<br>102313079<br>104113015<br>104113019<br>104113105<br>104113109 |  Náhradná WC kefa bez rukoväte<br>Spare WC brush without handle                          | 4,0                        | 4,8                        | 131567008c                            |
| 104113015<br>104113019<br>104113105<br>104113109  |  Náhradná sklenená miska na WC kefu, mliečne sklo<br>Glass dish for WC brush, frosted    | 5,4                        | 6,5                        | 131567003                             |
| 104108045   |  Náhradná miska pre mydelničku, mliečne sklo<br>Soap dish, ceramics                      | 3,8                        | 4,5                        | 131567002m                            |
| 104110015<br>104210025  |  Náhradný pohár, mliečne sklo<br>Glass cup, frosted                                      | 3,0                        | 3,6                        | 131567001m                            |
| 104109016   |  Náhradné sklo pre dávkovač, mliečne sklo<br>Glass for soap dispenser, frosted           | 21,0                       | 25,2                       | 131567243                             |
| 104109115   |  Náhradné sklo pre dávkovač MINI, mliečne sklo<br>Glass for soap dispenser MINI, frosted | 5,3                        | 6,3                        | 131567111                             |
| 104109035   |  Náhradná pumpička k dávkovaču mydla<br>Spare pump complete, chrome                      | 13,8                       | 16,5                       | 131567156                             |
| 104109015<br>104109016<br>104109115   |  Náhradná pumpička k dávkovaču mydla<br>Spare pump complete, chrome                      | 13,8                       | 16,5                       | 131567205                             |
| 104102045   |  Náhradné sklo k poličke, mliečne sklo<br>Glass for shelf, frosted                       | 7,3                        | 8,7                        | 131567011                             |
| 104102015   |  Náhradní sklo na rohovou poličku, mliečne sklo<br>Glass for corner shelf, frosted       | 6,5                        | 7,8                        | 131567047                             |
| <b>VIA</b>  |   |                            |                            |                                       |
| 118113092   |  Náhradná WC kefa s rukoväťou a krytkou<br>Spare WC brush incl. handle with vessel cover | 27,1                       | 32,5                       | 131567142                             |
| 135013012   |  Náhradná WC kefa s rukoväťou a krytkou<br>Spare WC brush incl. handle with vessel cover | 7,7                        | 9,2                        | 131567386                             |
| 118113092   |  Náhradná WC kefa bez rukoväte<br>Spare WC brush without handle                          | 4,0                        | 4,8                        | 131567158                             |

| Produkt<br>Product     | Náhradný diel<br>Spare part   | Cena €<br>bez DPH<br>Price | Cena €<br>vč. DPH<br>Price | Objednávkové číslo<br>Ordering number |
|------------------------|---|----------------------------|----------------------------|---------------------------------------|
| 118113092              |  Náhradná WC kefa bez rukoväte<br>Spare WC brush without handle                            | 4,0                        | 4,8                        | 131567158c                            |
| 135913091              |  Náhradná WC kefa bez rukoväte<br>Spare WC brush without handle                            | 2,8                        | 3,4                        | 131567384c                            |
| 118213092              |  Náhradná WC kefa bez rukoväte<br>Spare WC brush without handle                            | 2,7                        | 3,2                        | 131567012c                            |
| 135013012              |  Náhradná sklenená miska na WC kefu, mliečne sklo<br>Glass dish for WC brush, frosted      | 8,7                        | 10,4                       | 131567253                             |
| 135008022              |  Náhradná miska pre mydelničku, mliečne sklo<br>Soap dish, ceramics                        | 5,3                        | 6,4                        | 131567250                             |
| 135011012              |  Náhradný pohár, mliečne sklo<br>Glass cup, frosted  | 5,3                        | 6,4                        | 131567249                             |
| 135009042              |  Náhradní sklo pro dávkovač, mliečne sklo<br>Glass for soap dispenser, frosted             | 8,0                        | 9,6                        | 131567251                             |
| 135009042              |  Náhradná pumpička k dávkovaču mydla<br>Spare pump complete, chrome                        | 13,8                       | 16,5                       | 131567204                             |
| 135002242              |  Náhradné sklo k poličke, mliečne sklo<br>Glass for shelf, frosted                         | 10,0                       | 12,0                       | 131567254                             |
| <b>TREND-i</b>         |   |                            |                            |                                       |
| 104113018              |  Náhradná WC kefa s rukoväťou<br>Spare WC brush with handle                                | 7,9                        | 9,4                        | 131567009                             |
| 104113018              |  Náhradná WC kefa s rukoväťou<br>Spare WC brush with handle                                | 7,9                        | 9,4                        | 131567009c                            |
| 104113018              |  Náhradná WC kefa bez rukoväte<br>Spare WC brush without handle                           | 4,0                        | 4,8                        | 131567008                             |
| 104113018              |  Náhradná WC kefa bez rukoväte<br>Spare WC brush without handle                          | 4,0                        | 4,8                        | 131567008c                            |
| 104113018              |  Náhradná sklenená miska na WC kefu, mliečne sklo<br>Glass dish for WC brush, frosted    | 5,4                        | 6,5                        | 131567003                             |
| 104110018              |  Náhradný pohár, mliečne sklo<br>Glass cup, frosted                                      | 3,0                        | 3,6                        | 131567001m                            |
| 104109018              |  Náhradné sklo pre dávkovač, mliečne sklo<br>Glass for soap dispenser, frosted           | 21,0                       | 25,2                       | 131567243                             |
| 104109018              |  Náhradná pumpička k dávkovaču mydla<br>Spare pump complete, chrome                      | 13,8                       | 16,5                       | 131567204                             |
| <b>PLAZA</b>           |   |                            |                            |                                       |
| 118113092              |  Náhradná WC kefa s rukoväťou a krytkou<br>Spare WC brush incl. handle with vessel cover | 27,1                       | 32,5                       | 131567142                             |
| 118113012              |  Náhradná WC kefa s rukoväťou a krytkou<br>Spare WC brush incl. handle with vessel cover | 21,0                       | 25,2                       | 131567198                             |
| 118113012              |  Náhradná WC kefa bez rukoväte<br>Spare WC brush without handle                          | 4,0                        | 4,8                        | 131567158                             |
| 118113012              |  Náhradná WC kefa bez rukoväte<br>Spare WC brush without handle                          | 4,0                        | 4,8                        | 131567158c                            |
| 118113092              |  Náhradná WC kefa bez rukoväte<br>Spare WC brush without handle                          | 4,0                        | 4,8                        | 131567008                             |
| 118113012              |  Náhradná sklenená miska na WC kefu, mliečne sklo<br>Glass dish for WC brush, frosted    | 10,5                       | 12,6                       | 131567041                             |
| 118108022              |  Náhradná miska pre mydelničku, mliečne sklo<br>Soap dish, ceramics                      | 8,8                        | 10,5                       | 131567039                             |
| 140108191              |  Náhradná miska pre mydelničku, mliečne sklo<br>Soap dish, ceramics                      | 8,9                        | 10,7                       | 131567146                             |
| 118110052              |  Náhradný pohár, mliečne sklo<br>Glass cup, frosted                                      | 8,8                        | 10,5                       | 131567040                             |
| 118210019<br>140110061 |  Náhradný pohár, mliečne sklo<br>Glass cup, frosted                                      | 8,8                        | 10,5                       | 131567199                             |
| 118109042              |  Náhradný pohár, mliečne sklo<br>Glass cup, frosted                                      | 26,3                       | 31,5                       | 131567035                             |
| 118109042              |  Náhradná pumpička k dávkovaču mydla<br>Spare pump complete, chrome                      | 13,8                       | 16,5                       | 131567204                             |

# NÁHRADNÉ DIELY/SPARE PARTS

| Produkt<br>Product   | Náhradný diel<br>Spare part   | Cena €<br>bez DPH<br>Price | Cena €<br>vč. DPH<br>Price | Objednávkové číslo<br>Ordering number |
|--|---|----------------------------|----------------------------|---------------------------------------|
| 118209049<br>140109161   |  Náhradní sklo pro dávkovač, mliečne sklo<br>Glass for soap dispenser, frosted             | 16,7                       | 20,0                       | 131567044                             |
| 118209049<br>140109161   |  Náhradná pumpička k dávkovaču mydla<br>Spare pump complete, chrome                        | 18,4<br>13,8               | 22,1<br>16,5               | 131567118<br>131567159                |
| <b>RETRO</b>   |   |                            |                            |                                       |
| 144213018<br>144313012   |  Náhradná WC kefa s rukoväťou<br>Spare WC brush with handle                                | 7,9                        | 9,4                        | 131567009                             |
| 144113017  |  Náhradná WC kefa s rukoväťou<br>Spare WC brush with handle                                | 7,6                        | 9,1                        | 131567172                             |
| 144213018<br>144313012   |  Náhradná WC kefa s rukoväťou<br>Spare WC brush with handle                                | 7,9                        | 9,4                        | 131567009c                            |
| 144113017  |  Náhradná WC kefa s rukoväťou<br>Spare WC brush with handle                                |                            |                            | 131567420                             |
| 144113017<br>144213018<br>144313012  |  Náhradná WC kefa bez rukoväte<br>Spare WC brush without handle                            | 4,0                        | 4,8                        | 131567008                             |
| 144113017<br>144213018<br>144313012  |  Náhradná WC kefa bez rukoväte<br>Spare WC brush without handle                            | 4,0                        | 4,8                        | 131567008c                            |
| 144113017<br>144213018<br>144313012  |  Náhradná sklenená miska na WC kefu, mliečne sklo<br>Glass dish for WC brush, frosted     | 5,4                        | 6,5                        | 131567003                             |
| 144108027<br>144208028<br>144308022  |  Náhradná miska pre mydelničku, mliečne sklo<br>Soap dish, ceramics                      | 3,8                        | 4,5                        | 131567002m                            |
| 144110017<br>144110027<br>144210018<br>144210028<br>144310012<br>144310022 |  Náhradný pohár, mliečne sklo<br>Glass cup, frosted                                      | 3,0                        | 3,6                        | 131567001m                            |
| 144109017<br>144209018<br>144309012  |  Náhradné sklo pre dávkovač, mliečne sklo<br>Glass for soap dispenser, frosted           | 21,0                       | 25,2                       | 131567243                             |
| 144109107<br>144209108<br>144309102  |  Náhradné sklo pre dávkovač MINI, mliečne sklo<br>Glass for soap dispenser MINI, frosted | 5,3                        | 6,3                        | 131567111                             |
| 144109017<br>144109107   |  Náhradná pumpička k dávkovaču mydla<br>Spare pump complete, chrome                      | 17,2                       | 20,6                       | 131567441                             |
| 144309012<br>144209018<br>144309102<br>144209108                           |  Náhradná pumpička k dávkovaču mydla<br>Spare pump complete, chrome                      | 13,8                       | 16,5                       | 131567442                             |
| <b>OVAL</b>  |   |                            |                            |                                       |
| 118413011  |  Náhradná WC kefa s rukoväťou<br>Spare WC brush with handle                              | 7,2                        | 8,6                        | 131567018                             |
| 118413011  |  Náhradná WC kefa s rukoväťou<br>Spare WC brush with handle                              | 7,2                        | 8,6                        | 131567018c                            |
| 118413011  |  Náhradná WC kefa bez rukoväte<br>Spare WC brush without handle                          | 5,4                        | 6,5                        | 131567012                             |
| 118413011  |  Náhradná sklenená miska na WC kefu, mliečne sklo<br>Glass dish for WC brush, frosted    | 5,4                        | 6,5                        | 131567122                             |
| 118408021  |  Náhradná miska pre mydelničku, mliečne sklo<br>Soap dish, ceramics                      | 4,0                        | 4,8                        | 131567389                             |
| 118410011  |  Náhradný pohár, mliečne sklo<br>Glass cup, frosted                                      | 3,0                        | 3,6                        | 131567001m                            |
| 118409011  |  Náhradní sklo pro dávkovač, mliečne sklo<br>Glass for soap dispenser, frosted           | 9,7                        | 11,6                       | 131567126                             |

| Produkt<br>Product   | Náhradný diel<br>Spare part  | Cena €<br>bez DPH<br>Price | Cena €<br>vč. DPH<br>Price | Objednávkové číslo<br>Ordering number |
|--|--|----------------------------|----------------------------|---------------------------------------|
| 118409011  |  Náhradná pumpička k dávkovaču mydla<br>Spare pump complete, chrome                     | 18,4                       | 22,1                       | 131567118                             |
| 118402031  |  Náhradné sklo k poličke, mliečne sklo<br>Glass for shelf, frosted                      | 6,2                        | 7,5                        | 131567121                             |
| <b>NIKI</b>  |  |                            |                            |                                       |
| 153113012  |  Náhradná WC kefa s rukoväťou<br>Spare WC brush with handle                             | 7,9                        | 9,4                        | 131567009                             |
| 153113012  |  Náhradná WC kefa s rukoväťou<br>Spare WC brush with handle                             | 7,9                        | 9,4                        | 131567009c                            |
| 153113012  |  Náhradná WC kefa bez rukoväte<br>Spare WC brush without handle                         | 4,0                        | 4,8                        | 131567008                             |
| 153113012  |  Náhradná WC kefa bez rukoväte<br>Spare WC brush without handle                         | 4,0                        | 4,8                        | 131567008c                            |
| 153113012  |  Náhradná sklenená miska na WC kefu, mliečne sklo<br>Glass dish for WC brush, frosted   | 9,6                        | 11,5                       | 131567372                             |
| 153108022  |  Náhradná miska pre mydelničku, mliečne sklo<br>Soap dish, ceramics                     | 4,8                        | 5,7                        | 131567370                             |
| 153110052  |  Náhradný pohár, mliečne sklo<br>Glass cup, frosted                                     | 4,8                        | 5,7                        | 131567368                             |
| 153209049  |  Náhradní sklo pro dávkovač, mliečne sklo<br>Glass for soap dispenser, frosted          | 11,3                       | 13,5                       | 131567371                             |
| 153209049  |  Náhradná pumpička k dávkovaču mydla<br>Spare pump complete, chrome                    | 4,2                        | 5,0                        | 131567369                             |
| 153102042  |  Náhradné sklo k poličke, mliečne sklo<br>Glass for shelf, frosted                    | 4,2                        | 5,0                        | 131567179                             |
| <b>ALFA</b>  |  |                            |                            |                                       |
| 102413012  |  Náhradná WC kefa s rukoväťou<br>Spare WC brush with handle                           | 7,2                        | 8,6                        | 131567018                             |
| 102413012  |  Náhradná WC kefa s rukoväťou<br>Spare WC brush with handle                           | 7,2                        | 8,6                        | 131567018c                            |
| 102413012  |  Náhradná WC kefa bez rukoväte<br>Spare WC brush without handle                       | 2,7                        | 3,2                        | 131567012                             |
| 102413012  |  Náhradná sklenená miska na WC kefu, mliečne sklo<br>Glass dish for WC brush, frosted | 5,4                        | 6,5                        | 131567113                             |
| 102408023  |  Náhradná miska pre mydelničku, mliečne sklo<br>Soap dish, ceramics                   | 3,8                        | 4,5                        | 131567002m                            |
| 102410012  |  Náhradný pohár, mliečne sklo<br>Glass cup, frosted                                   | 3,0                        | 3,6                        | 131567001m                            |
| 102408022  |  Náhradní sklo pro dávkovač, mliečne sklo<br>Glass for soap dispenser, frosted        |                            |                            | 131567380                             |
| 102408022  |  Náhradná pumpička k dávkovaču mydla<br>Spare pump complete, chrome                   | 7,9                        | 9,5                        | 131567178                             |
| 102402242  |  Náhradné sklo k poličke, mliečne sklo<br>Glass for shelf, frosted                    | 6,9                        | 8,3                        | 131567191                             |
| <b>SILIKON</b>   |  |                            |                            |                                       |
|  |  WC štětka s rukojetí<br>WC brush with handle   | 9,8                        | 11,7                       | 131567448                             |
| TASI 154113012/OMEGA 104113102, 104113012, 104913152, 104913122, 104913112, 104913092, 104113017, 104913152, 104913122, 104913117, 104913092, 104113107/BETA 132113012, 132113017/VIA 135013012/TREND-i 104113018/NIKI 153113012   |  |                            |                            |                                       |
| ALFA 102413012/104836012, 132836012  |  |                            |                            |                                       |
|  |  Náhradní silikonový WC kartáč bez rukojeti<br>Spare WC brush without handle          | 6,0                        | 7,2                        | 131567447                             |
| DARK 102313060, 104113010/KERA 144713017/TASI 154113012/OMEGA 102313066, 104113012, 104913152, 104913122W, 104913117, 104913112, 104913092W, 104913090, 104113107, 102313057W/BETA 132113012, 132113017/NEO 104113015, 102313075, 102313065, 104113109, 104113105, 102313059, 102313055, 102313067, 102313079/TREND-i 104113018/RETRO CHRÓM 144313012/RETRO BRONZ 144113017/RETRO GOLD 144213018/NIKI 153113012/104836012, 132836012 |  |                            |                            |                                       |

# HELP

## Držadlo – nerez lesk

Grab bar – stainless steel polished

120 Kg

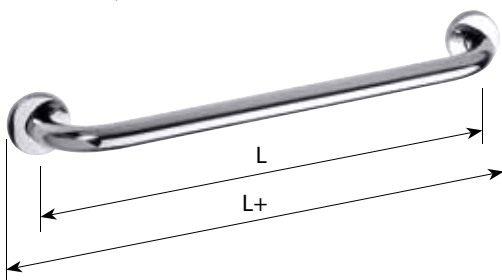

Držadlo – nerez brus  
Grab bar – stainless steel matt



Držadlo – komaxit biely  
Grab bar – steel powder coated white



NOVINKA



Držadlo – komaxit biely s krytkou  
Grab bar with cover, steel powder coated white



| Šírka držadla [L]<br>Product length [L] | Povrchová úprava<br>Finish       | Cena € bez DPH | Cena € vč. DPH | Objednávkové číslo<br>Ordering number |
|---|----------------------------------|----------------|----------------|---------------------------------------|
|   |                                  | Price €        | Price €        |                                       |
| 200 mm                                  | nerez/stainless                  | 23,4           | 28,0           | 301100201                             |
|   | brus/matt                        | 25,1           | 30,2           | 301100202                             |
|   | biela/white                      | 13,7           | 16,5           | 301100204                             |
|   | biela s krytkou/white with cover | 22,5           | 27,0           | 301100203                             |
| 300 mm                                  | nerez/stainless                  | 27,5           | 33,0           | 301100301                             |
|   | brus/matt                        | 29,9           | 35,8           | 301100302                             |
|   | biela/white                      | 16,1           | 19,3           | 301100304                             |
|   | biela s krytkou/white with cover | 23,8           | 28,6           | 301100303                             |
| 400 mm                                  | nerez/stainless                  | 29,9           | 35,9           | 301100401                             |
|   | brus/matt                        | 32,3           | 38,8           | 301100402                             |
|   | biela/white                      | 17,2           | 20,6           | 301100404                             |
|   | biela s krytkou/white with cover | 25,4           | 30,5           | 301100403                             |
| 500 mm                                  | nerez/stainless                  | 33,7           | 40,4           | 301100501                             |
|   | brus/matt                        | 36,4           | 43,7           | 301100502                             |
|   | biela/white                      | 18,9           | 22,6           | 301100504                             |
|   | biela s krytkou/white with cover | 27,1           | 32,5           | 301100503                             |
| 600 mm                                  | nerez/stainless                  | 36,1           | 43,3           | 301100601                             |
|   | brus/matt                        | 39,1           | 46,9           | 301100602                             |
|   | biela/white                      | 22,7           | 27,2           | 301100604                             |
|   | biela s krytkou/white with cover | 28,8           | 34,6           | 301100603                             |
| 700 mm                                  | nerez/stainless                  | 39,9           | 47,9           | 301100701                             |
|   | brus/matt                        | 43,3           | 51,9           | 301100702                             |
|   | biela/white                      | 23,7           | 28,4           | 301100704                             |
|   | biela s krytkou/white with cover | 30,4           | 36,5           | 301100703                             |
| 800 mm                                  | nerez/stainless                  | 39,9           | 47,9           | 301100801                             |
|   | brus/matt                        | 43,3           | 51,9           | 301100802                             |
|   | biela/white                      | 28,5           | 34,2           | 301100804                             |
|   | biela s krytkou/white with cover | 30,8           | 37,0           | 301100803                             |
| 900 mm                                  | nerez/stainless                  | 48,1           | 57,8           | 301100901                             |
|   | brus/matt                        | 52,0           | 62,4           | 301100902                             |
|   | biela/white                      | 30,5           | 36,6           | 301100904                             |
|   | biela s krytkou/white with cover | 33,3           | 40,0           | 301100903                             |
| 1000 mm                                 | nerez/stainless                  | 52,3           | 62,7           | 301101001                             |
|   | brus/matt                        | 56,4           | 67,7           | 301101002                             |
|   | biela/white                      | 32,3           | 38,8           | 301101004                             |
|   | biela s krytkou/white with cover | 36,7           | 44,0           | 301101003                             |
| 1100 mm                                 | nerez/stainless                  | 54,3           | 65,2           | 301101101                             |
|   | brus/matt                        | 58,5           | 70,2           | 301101102                             |
|   | biela/white                      | 34,4           | 41,2           | 301101104                             |
|   | biela s krytkou/white with cover | 45,8           | 55,0           | 301101103                             |
| 1200 mm                                 | nerez/stainless                  | 57,1           | 68,5           | 301101201                             |
|   | brus/matt                        | 61,6           | 73,9           | 301101202                             |
|   | biela/white                      | 37,8           | 45,4           | 301101204                             |
|   | biela s krytkou/white with cover | 47,9           | 57,5           | 301101203                             |
| 1500 mm                                 | nerez/stainless                  | 72,9           | 87,5           | 301101501                             |
|   | brus/matt                        | 78,8           | 94,5           | 301101502                             |
|   | biela/white                      | 45,3           | 54,3           | 301101504                             |
|   | biela s krytkou/white with cover | 54,2           | 65,0           | 301101503                             |

**Podporné držadlo v tvare U**  
Grab bar U-shaped

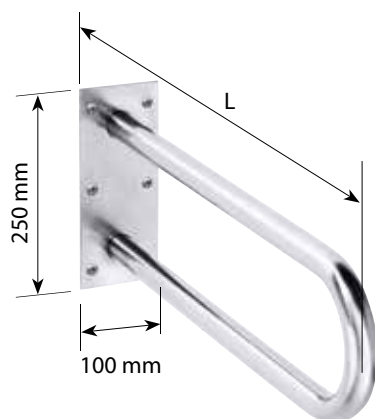

| Šírka držadla [L]<br>Product length [L] | Povrchová úprava<br>Finish          | Cena € bez DPH<br>Price € | Cena € vč. DPH<br>Price € | Objednávkové číslo<br>Ordering number |
|---|-------------------------------------|---------------------------|---------------------------|---------------------------------------|
| <b>600 mm</b>                           | nerez/stainless                     | <b>52,6</b>               | <b>63,1</b>               | <b>301102051</b>                      |
|   | nerez s krytkou/polished with cover | 70,0                      | 84,0                      | 301707271                             |
|   | brus/matt                           | 56,8                      | 68,1                      | 301102052                             |
|   | brus s krytkou/matt with cover      | 70,0                      | 84,0                      | 301707272                             |
|   | biela/white                         | 33,4                      | 40,0                      | 301102054                             |
|   | biela s krytkou/white with cover    | 49,2                      | 59,0                      | 301707273                             |
| <b>750 mm</b>                           | nerez/stainless                     | <b>58,3</b>               | <b>70,0</b>               | <b>301102301</b>                      |
|   | nerez s krytkou/polished with cover | 75,0                      | 90,0                      | 301707301                             |
|   | brus/matt                           | 66,7                      | 80,0                      | 301102302                             |
|   | brus s krytkou/matt with cover      | 75,0                      | 90,0                      | 301707302                             |
|   | biela/white                         | 35,4                      | 42,5                      | 301102304                             |
|   | biela s krytkou/white with cover    | 52,5                      | 63,0                      | 301707303                             |
| <b>813 mm</b>                           | nerez/stainless                     | <b>61,9</b>               | <b>74,3</b>               | <b>301102061</b>                      |
|   | nerez s krytkou/polished with cover | 79,2                      | 95,0                      | 301707461                             |
|   | brus/matt                           | 67,1                      | 80,5                      | 301102062                             |
|   | brus s krytkou/matt with cover      | 79,2                      | 95,0                      | 301707462                             |
|   | biela/white                         | 36,1                      | 43,3                      | 301102064                             |
|   | biela s krytkou/white with cover    | 52,1                      | 62,5                      | 301707463                             |
| <b>850 mm</b>                           | nerez/stainless                     | <b>81,3</b>               | <b>98,0</b>               | <b>301102041</b>                      |
|   | nerez s krytkou/polished with cover | 88,3                      | 106,0                     | 301707321                             |
|   | brus/matt                           | 70,8                      | 85,0                      | 301102042                             |
|   | brus s krytkou/matt with cover      | 83,3                      | 100,0                     | 301707322                             |
|   | biela/white                         | 41,7                      | 50,0                      | 301102044                             |
|   | biela s krytkou/white with cover    | 56,3                      | 68,0                      | 301707323                             |
| <b>900 mm</b>                           | nerez/stainless                     | <b>67,1</b>               | <b>80,5</b>               | <b>301102991</b>                      |
|   | nerez s krytkou/polished with cover | 87,5                      | 105,0                     | 301707331                             |
|   | brus/matt                           | 71,9                      | 86,3                      | 301102992                             |
|   | brus s krytkou/matt with cover      | 87,5                      | 105,0                     | 301707332                             |
|   | biela/white                         | 41,9                      | 50,3                      | 301102994                             |
|   | biela s krytkou/white with cover    | 58,3                      | 70,0                      | 301707333                             |

**Držadlo s chrbtovou opierkou**  
Toilet seat back rest

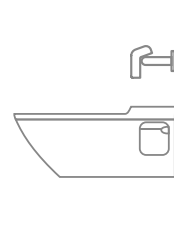
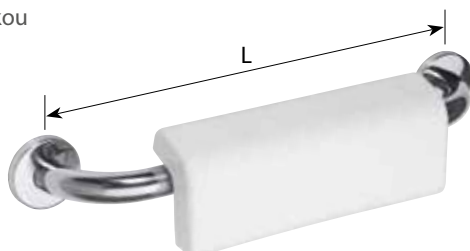

|               |                                     |              |              |                    |
|---------------|-------------------------------------|--------------|--------------|--------------------|
| <b>350 mm</b> | nerez s krytkou/polished with cover | <b>99,2</b>  | <b>119,0</b> | <b>301100351-o</b> |
|               | brus s krytkou/matt with cover      | 106,7        | 128,0        | 301100352-o        |
|               | biela/white                         | 70,4         | 84,5         | 301100354-o        |
|               | biela s krytkou/white with cover    | 74,2         | 89,0         | 301100353-o        |
| <b>500 mm</b> | nerez s krytkou/polished with cover | <b>103,0</b> | <b>123,6</b> | <b>301100501-o</b> |
|               | brus s krytkou/matt with cover      | 111,0        | 133,2        | 301100502-o        |
|               | biela/white                         | 74,0         | 88,8         | 301100504-o        |
|               | biela s krytkou/white with cover    | 80,2         | 96,2         | 301100503-o        |

# HELP

Podporné držadlo v tvare U  
s držiakom toaletného papiera  
Grab bar U-shaped  
with toilet paper holder



NEW

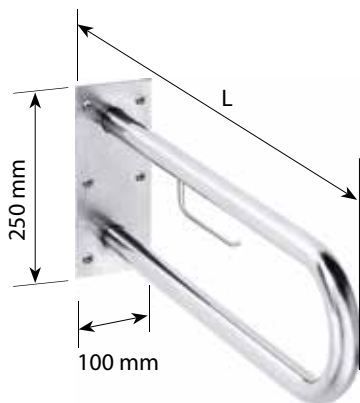

| Šírka držadla [L]<br>Product length [L] | Povrchová úprava<br>Finish          | Cena € bez DPH<br>Price € | Cena € vč. DPH<br>Price € | Objednávkové číslo<br>Ordering number |
|---|-------------------------------------|---------------------------|---------------------------|---------------------------------------|
| 600 mm                                  | nerez/stainless                     | 62,1                      | 74,5                      | 301907271                             |
|   | brus/matt                           | 66,3                      | 80,0                      | 301907272                             |
|   | biela/white                         | 40,8                      | 49,0                      | 301907274                             |
| 750 mm                                  | nerez/stainless                     | 70,4                      | 84,5                      | 301907301                             |
|   | brus/matt                           | 74,6                      | 89,5                      | 301907302                             |
|   | biela/white                         | 45,0                      | 54,0                      | 301907304                             |
| 813 mm                                  | nerez/stainless                     | 70,4                      | 84,5                      | 301907461                             |
|   | nerez s krytkou/polished with cover | 93,8                      | 112,6                     | 301807461                             |
|   | brus/matt                           | 76,7                      | 92,0                      | 301907462                             |
|   | brus s krytkou/matt with cover      | 97,9                      | 117,5                     | 301807462                             |
|   | biela/white                         | 45,4                      | 54,5                      | 301907464                             |
|   | biela s krytkou/white with cover    | 70,8                      | 85,0                      | 301807463                             |
| 850 mm                                  | nerez/stainless                     | 77,8                      | 93,4                      | 301907321                             |
|   | brus/matt                           | 82,5                      | 99,0                      | 301907322                             |
|   | biela/white                         | 53,8                      | 64,6                      | 301907324                             |
| 900 mm                                  | nerez/stainless                     | 77,1                      | 92,5                      | 301907331                             |
|   | nerez s krytkou/polished with cover | 95,8                      | 115,0                     | 301807331                             |
|   | brus/matt                           | 82,5                      | 99,0                      | 301907332                             |
|   | brus s krytkou/matt with cover      | 100,0                     | 120,0                     | 301807332                             |
|   | biela/white                         | 54,2                      | 65,0                      | 301907334                             |
|   | biela s krytkou/white with cover    | 72,9                      | 87,5                      | 301807333                             |

## Držiak sprchy Shower holder



Držiak sprchy možno použiť pre/Can be used for:



### Držiak/Grab bar:

|         |                 |
|---------|-----------------|
| 500 mm  | 301100501,2,4,3 |
| 600 mm  | 301100601,2,4,3 |
| 700 mm  | 301100701,2,4,3 |
| 800 mm  | 301100801,2,4,3 |
| 900 mm  | 301100901,2,4,3 |
| 1000 mm | 301101001,2,4,3 |
| 1100 mm | 301101101,2,4,3 |
| 1200 mm | 301101201,2,4,3 |
| 1500 mm | 301101501,2,4,3 |

### Sprchový držiak Shower grab bar:

|        |                 |
|--------|-----------------|
| 890 mm | 301122041,2,4,3 |
|        | 301112041,2,4,3 |
| 680 mm | 301112061,2,4,3 |
|        | 301112071,2,4,3 |

### Sprchový držiak/Shower grab bar:

|  |                 |
|--|-----------------|
|  | 301122021,2,4,3 |
|  | 301112021,2,4,3 |

Jednoduchá inštalácia:  
Easy installation:

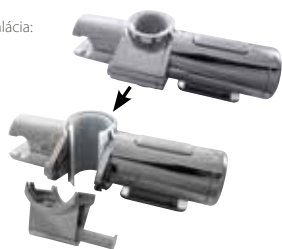

| Povrchová úprava<br>Finish    | Cena € bez DPH<br>Price € | Cena € vč. DPH<br>Price € | Objednávkové číslo<br>Ordering number |
|-------------------------------|---------------------------|---------------------------|---------------------------------------|
| plast, chrom/plastic, chromed | 34,4                      | 41,2                      | 338514372                             |



**Sklopný úchyt v tvare U**  
Foldable grab bar U-shaped

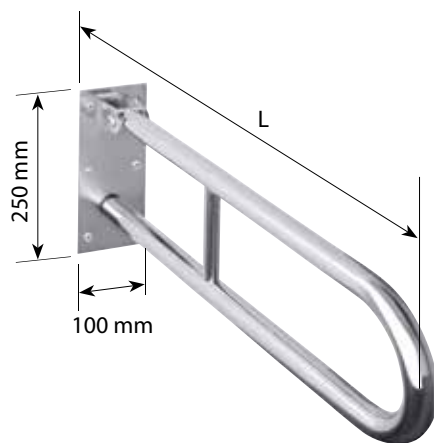

| Šírka držadla [L]<br>Product length [L] | Povrchová úprava<br>Finish          | Cena € bez DPH<br>Price € | Cena € vč. DPH<br>Price € | Objednávkové číslo<br>Ordering number |
|---|-------------------------------------|---------------------------|---------------------------|---------------------------------------|
| 600 mm                                  | nerez/stainless                     | 85,7                      | 102,8                     | 301102071                             |
|   | nerez s krytkou/polished with cover | 103,5                     | 124,2                     | 301607271                             |
|   | brus/matt                           | 92,6                      | 111,1                     | 301102072                             |
|   | brus s krytkou/matt with cover      | 103,5                     | 124,2                     | 301607272                             |
|   | biela/white                         | 41,3                      | 49,5                      | 301102074                             |
|   | biela s krytkou/white with cover    | 62,5                      | 75,0                      | 301607273                             |
| 750 mm                                  | nerez/stainless                     | 92,9                      | 111,5                     | 301606301                             |
|   | nerez s krytkou/polished with cover | 105,8                     | 127,0                     | 301607301                             |
|   | brus/matt                           | 100,8                     | 121,0                     | 301606302                             |
|   | brus s krytkou/matt with cover      | 105,8                     | 127,0                     | 301607302                             |
|   | biela/white                         | 55,0                      | 66,0                      | 301606304                             |
|   | biela s krytkou/white with cover    | 63,5                      | 76,2                      | 301607303                             |
| 813 mm                                  | nerez/stainless                     | 93,3                      | 111,9                     | 301102081                             |
|   | nerez s krytkou/polished with cover | 110,0                     | 132,0                     | 301607471                             |
|   | brus/matt                           | 100,9                     | 121,1                     | 301102082                             |
|   | brus s krytkou/matt with cover      | 110,0                     | 132,0                     | 301607472                             |
|   | biela/white                         | 46,7                      | 56,1                      | 301102084                             |
|   | biela s krytkou/white with cover    | 60,4                      | 72,5                      | 301607473                             |
| 850 mm                                  | nerez/stainless                     | 102,1                     | 122,5                     | 301606321                             |
|   | nerez s krytkou/polished with cover | 114,2                     | 137,0                     | 301607321                             |
|   | brus/matt                           | 107,9                     | 129,5                     | 301606322                             |
|   | brus s krytkou/matt with cover      | 114,2                     | 137,0                     | 301607322                             |
|   | biela/white                         | 54,2                      | 65,0                      | 301606324                             |
|   | biela s krytkou/white with cover    | 64,6                      | 77,5                      | 301607323                             |
| 900 mm                                  | nerez/stainless                     | 98,1                      | 117,7                     | 301102901                             |
|   | nerez s krytkou/polished with cover | 115,0                     | 138,0                     | 301607331                             |
|   | brus/matt                           | 102,9                     | 123,5                     | 301102902                             |
|   | brus s krytkou/matt with cover      | 115,0                     | 138,0                     | 301607332                             |
|   | biela/white                         | 51,6                      | 61,9                      | 301102904                             |
|   | biela s krytkou/white with cover    | 62,5                      | 75,0                      | 301607333                             |



# HELP

1

**Sklopný úchyt v tvare U s držiakom toaletného papiera**  
Foldable grab bar U-shaped with toilet paper holder

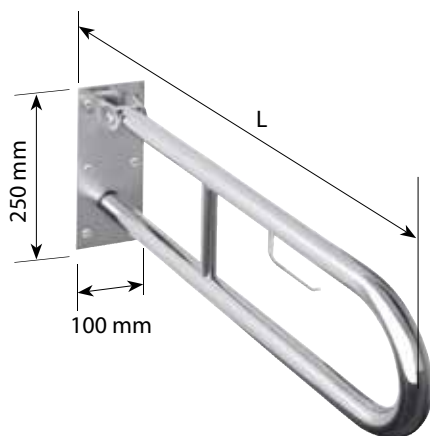

2

**Sklopný úchyt ukotvený do zeme**  
Foldable grab bar, ground mounted

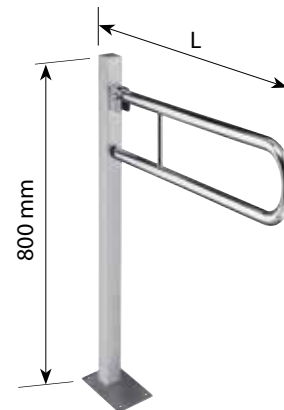

| Šírka držadla [L]<br>Product length [L] | Povrchová úprava<br>Finish          | Cena € bez DPH | Cena € vč. DPH | Objednávkové číslo<br>Ordering number |
|---|-------------------------------------|----------------|----------------|---------------------------------------|
|   |                                     | Price €        | Price €        |                                       |
| 600 mm                                  | nerez/stainless                     | 100,0          | 120,0          | 301102271                             |
|   | nerez s krytkou/polished with cover | 111,7          | 134,0          | 301407271                             |
|   | brus/matt                           | 106,7          | 128,0          | 301406272                             |
|   | brus s krytkou/matt with cover      | 115,8          | 139,0          | 301407272                             |
|   | biela/white                         | 59,2           | 71,0           | 301406274                             |
|   | biela s krytkou/white with cover    | 65,8           | 79,0           | 301407273                             |
| 750 mm                                  | nerez/stainless                     | 102,1          | 122,5          | 301406301                             |
|   | nerez s krytkou/polished with cover | 115,8          | 139,0          | 301407301                             |
|   | brus/matt                           | 108,8          | 130,6          | 301406302                             |
|   | brus s krytkou/matt with cover      | 120,0          | 144,0          | 301407302                             |
|   | biela/white                         | 59,6           | 71,5           | 301406304                             |
|   | biela s krytkou/white with cover    | 70,0           | 84,0           | 301407303                             |
| 813 mm                                  | nerez/stainless                     | 103,0          | 123,6          | 301102281                             |
|   | nerez s krytkou/polished with cover | 120,0          | 144,0          | 301407281                             |
|   | brus/matt                           | 110,1          | 132,1          | 301102282                             |
|   | brus s krytkou/matt with cover      | 124,2          | 149,0          | 301407282                             |
|   | biela/white                         | 60,3           | 72,3           | 301102284                             |
|   | biela s krytkou/white with cover    | 74,2           | 89,0           | 301407283                             |
| 850 mm                                  | nerez/stainless                     | 107,1          | 128,5          | 301406321                             |
|   | nerez s krytkou/polished with cover | 124,2          | 149,0          | 301407321                             |
|   | brus/matt                           | 114,6          | 137,0          | 301406322                             |
|   | brus s krytkou/matt with cover      | 128,3          | 154,0          | 301407322                             |
|   | biela/white                         | 65,8           | 79,0           | 301406324                             |
|   | biela s krytkou/white with cover    | 78,3           | 94,0           | 301407323                             |
| 900 mm                                  | nerez/stainless                     | 107,7          | 129,3          | 301102291                             |
|   | nerez s krytkou/polished with cover | 124,2          | 149,0          | 301407291                             |
|   | brus/matt                           | 114,3          | 137,1          | 301102292                             |
|   | brus s krytkou/matt with cover      | 128,3          | 154,0          | 301407292                             |
|   | biela/white                         | 55,0           | 66,0           | 301102294                             |
|   | biela s krytkou/white with cover    | 69,2           | 83,0           | 301407293                             |
| 750 mm                                  | nerez/stainless                     | 177,0          | 212,4          | 301107301                             |
|   | nerez s krytkou/polished with cover | 197,9          | 237,5          | 301507301                             |
|   | brus/matt                           | 191,4          | 229,7          | 301107302                             |
|   | brus s krytkou/matt with cover      | 202,1          | 242,5          | 301507302                             |
|   | biela/white                         | 118,7          | 142,4          | 301107304                             |
|   | biela s krytkou/white with cover    | 143,8          | 172,6          | 301507303                             |
| 813 mm                                  | nerez/stainless                     | 181,1          | 217,4          | 301107601                             |
|   | nerez s krytkou/polished with cover | 202,1          | 242,5          | 301507601                             |
|   | brus/matt                           | 195,5          | 234,6          | 301107602                             |
|   | brus s krytkou/matt with cover      | 206,3          | 247,6          | 301507602                             |
|   | biela/white                         | 122,9          | 147,4          | 301107604                             |
|   | biela s krytkou/white with cover    | 147,9          | 177,5          | 301507603                             |
| 850 mm                                  | nerez/stainless                     | 185,3          | 222,4          | 301107321                             |
|   | nerez s krytkou/polished with cover | 202,1          | 242,5          | 301507321                             |
|   | brus/matt                           | 199,7          | 239,6          | 301107322                             |
|   | brus s krytkou/matt with cover      | 206,3          | 247,6          | 301507322                             |
|   | biela/white                         | 127,0          | 152,4          | 301107324                             |
|   | biela s krytkou/white with cover    | 147,9          | 177,5          | 301507323                             |

1  
Sklopný úchyt v tvare U  
s opornou nohou  
Foldable bar U-shaped

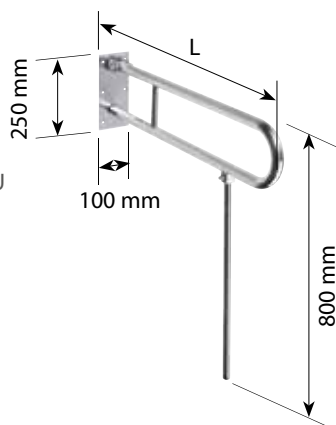

2

Sklopný úchyt v tvare U  
s opornou nohou  
a držiakom toaletného papiera  
Foldable bar U-shaped



NEW



BEMETA®

| Šírka držadla [L]<br>Product length [L] | Povrchová úprava<br>Finish          | Cena € bez DPH<br>Price € | Cena € vč. DPH<br>Price € | Objednávkové číslo<br>Ordering number |
|---|-------------------------------------|---------------------------|---------------------------|---------------------------------------|
| 1<br>600 mm                             | nerez/stainless                     | 100,0                     | 120,0                     | 301102071N                            |
|   | nerez s krytkou/polished with cover | 122,9                     | 147,5                     | 301307071N                            |
|   | brus/matt                           | 107,5                     | 129,0                     | 301102072N                            |
|   | brus s krytkou/matt with cover      | 123,3                     | 148,0                     | 301307072N                            |
|   | biela/white                         | 55,0                      | 66,0                      | 301102074N                            |
|   | biela s krytkou/white with cover    | 71,7                      | 86,0                      | 301307073N                            |
| 750 mm                                  | nerez/stainless                     | 100,0                     | 120,0                     | 301606301N                            |
|   | nerez s krytkou/polished with cover | 120,5                     | 144,6                     | 301307301N                            |
|   | brus/matt                           | 108,3                     | 130,0                     | 301606302N                            |
|   | brus s krytkou/matt with cover      | 124,5                     | 149,4                     | 301307302N                            |
|   | biela/white                         | 58,3                      | 70,0                      | 301606304N                            |
|   | biela s krytkou/white with cover    | 71,6                      | 86,0                      | 301307303N                            |
| 813 mm                                  | nerez/stainless                     | 102,5                     | 123,0                     | 301102081N                            |
|   | nerez s krytkou/polished with cover | 124,2                     | 149,0                     | 301307081N                            |
|   | brus/matt                           | 110,5                     | 132,6                     | 301102082N                            |
|   | brus s krytkou/matt with cover      | 124,2                     | 149,0                     | 301307082N                            |
|   | biela/white                         | 59,1                      | 70,9                      | 301102084N                            |
|   | biela s krytkou/white with cover    | 75,8                      | 91,0                      | 301307083N                            |
| 850 mm                                  | nerez/stainless                     | 110,8                     | 133,0                     | 301606321N                            |
|   | nerez s krytkou/polished with cover | 128,5                     | 154,2                     | 301307321N                            |
|   | brus/matt                           | 115,0                     | 138,2                     | 301606322N                            |
|   | brus s krytkou/matt with cover      | 130,5                     | 156,6                     | 301307322N                            |
|   | biela/white                         | 65,8                      | 79,0                      | 301606324N                            |
|   | biela s krytkou/white with cover    | 80,1                      | 96,1                      | 301307323N                            |
| 2<br>600 mm                             | nerez/stainless                     | 108,3                     | 130,0                     | 301102271N                            |
|   | nerez s krytkou/polished with cover | 130,0                     | 156,0                     | 301407271N                            |
|   | brus/matt                           | 118,8                     | 142,6                     | 301406272N                            |
|   | brus s krytkou/matt with cover      | 135,4                     | 162,5                     | 301407272N                            |
|   | biela/white                         | 67,5                      | 81,0                      | 301406274N                            |
|   | biela s krytkou/white with cover    | 90,8                      | 109,0                     | 301407273N                            |
| 750 mm                                  | nerez/stainless                     | 111,7                     | 134,0                     | 301406301N                            |
|   | nerez s krytkou/polished with cover | 132,5                     | 159,0                     | 301407301N                            |
|   | brus/matt                           | 119,2                     | 143,0                     | 301406302N                            |
|   | brus s krytkou/matt with cover      | 136,7                     | 164,0                     | 301407302N                            |
|   | biela/white                         | 70,0                      | 84,0                      | 301406304N                            |
|   | biela s krytkou/white with cover    | 85,8                      | 103,0                     | 301407303N                            |
| 813 mm                                  | nerez/stainless                     | 110,8                     | 133,0                     | 301102281N                            |
|   | nerez s krytkou/polished with cover | 138,3                     | 166,0                     | 301407281N                            |
|   | brus/matt                           | 118,8                     | 142,6                     | 301102282N                            |
|   | brus s krytkou/matt with cover      | 145,0                     | 174,0                     | 301407282N                            |
|   | biela/white                         | 68,8                      | 82,6                      | 301102284N                            |
|   | biela s krytkou/white with cover    | 95,0                      | 114,0                     | 301407283N                            |
| 850 mm                                  | nerez/stainless                     | 119,2                     | 143,0                     | 301406321N                            |
|   | nerez s krytkou/polished with cover | 139,6                     | 167,5                     | 301407321N                            |
|   | brus/matt                           | 120,4                     | 144,5                     | 301406322N                            |
|   | brus s krytkou/matt with cover      | 145,0                     | 174,0                     | 301407322N                            |
|   | biela/white                         | 72,9                      | 87,5                      | 301406324N                            |
|   | biela s krytkou/white with cover    | 95,4                      | 114,5                     | 301407323N                            |

# HELP

- ① Sklopný úchyt v tvare U s opornou nohou  
Foldable grab bar

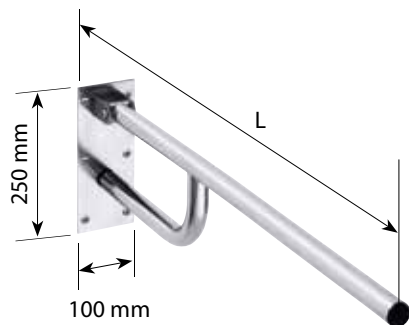

- ② Sklopný úchyt  
Foldable grab bar  
with toilet paper holder



| Šírka držadla [L]<br>Product length [L] | Povrchová úprava<br>Finish          | Cena € bez DPH<br>Price € | Cena € vč. DPH<br>Price € | Objednávkové číslo<br>Ordering number |
|---|-------------------------------------|---------------------------|---------------------------|---------------------------------------|
| ① 760 mm                                | nerez/stainless                     | 86,7                      | 104,1                     | 301102091                             |
|   | nerez s krytkou/polished with cover | 104,2                     | 125,0                     | 301607091                             |
|   | brus/matt                           | 93,7                      | 112,4                     | 301102092                             |
|   | brus s krytkou/matt with cover      | 108,3                     | 130,0                     | 301607092                             |
|   | biela/white                         | 48,1                      | 57,8                      | 301102094                             |
|   | biela s krytkou/white with cover    | 64,6                      | 77,5                      | 301607093                             |
| 850 mm                                  | nerez/stainless                     | 96,3                      | 115,6                     | 301102321                             |
|   | nerez s krytkou/polished with cover | 106,5                     | 127,8                     | 301607161                             |
|   | brus/matt                           | 102,1                     | 122,5                     | 301102322                             |
|   | brus s krytkou/matt with cover      | 109,5                     | 131,4                     | 301607162                             |
|   | biela/white                         | 51,3                      | 61,6                      | 301102324                             |
|   | biela s krytkou/white with cover    | 67,5                      | 82,2                      | 301607163                             |
| ② 600 mm                                | nerez/stainless                     | 95,4                      | 114,5                     | 301102771                             |
|   | nerez s krytkou/polished with cover | 116,2                     | 139,4                     | 301607771                             |
|   | brus/matt                           | 101,7                     | 122,0                     | 301102772                             |
|   | brus s krytkou/matt with cover      | 120,3                     | 144,4                     | 301607772                             |
|   | biela/white                         | 56,3                      | 67,6                      | 301102774                             |
|   | biela s krytkou/white with cover    | 76,6                      | 92,0                      | 301607773                             |
| 750 mm                                  | nerez/stainless                     | 106,7                     | 128,0                     | 301102781                             |
|   | nerez s krytkou/polished with cover | 118,5                     | 142,2                     | 301607781                             |
|   | brus/matt                           | 114,2                     | 137,0                     | 301102782                             |
|   | brus s krytkou/matt with cover      | 121,5                     | 145,8                     | 301607782                             |
|   | biela/white                         | 55,0                      | 66,0                      | 301102784                             |
|   | biela s krytkou/white with cover    | 79,5                      | 95,4                      | 301607783                             |

- ③ Uhlové držadlo 120°  
Angled grab bar 120°

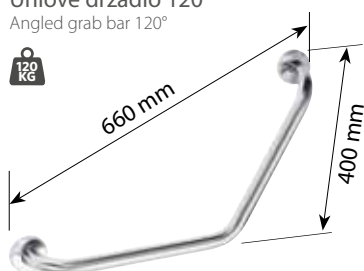

- ④ Držadlo do sprchy  
Shower grab bar

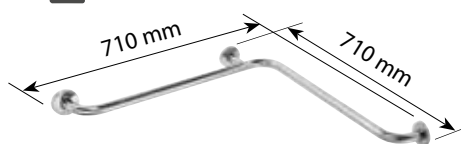

- ⑤ Ochrana sifónu proti nárazu  
invalidných vozíkov  
Protection of dip-pipe against wheelchair crash



|                |                                     |      |      |           |
|----------------|-------------------------------------|------|------|-----------|
| ③ 660 x 400 mm | nerez s krytkou/polished with cover | 47,5 | 56,9 | 301102011 |
|                | brus s krytkou/matt with cover      | 51,5 | 61,8 | 301102012 |
|                | biela/white                         | 30,5 | 36,6 | 301102014 |
|                | biela s krytkou/white with cover    | 41,7 | 50,0 | 301102013 |
| ④ 660 x 400 mm | nerez s krytkou/polished with cover | 76,3 | 91,5 | 301102031 |
|                | brus s krytkou/matt with cover      | 82,2 | 98,7 | 301102032 |
|                | biela/white                         | 37,8 | 45,4 | 301102034 |
|                | biela s krytkou/white with cover    | 49,6 | 59,5 | 301102033 |
| ⑤ 545 x 266 mm | nerez s krytkou/polished with cover | 43,7 | 52,4 | 301102121 |
|                | brus s krytkou/matt with cover      | 47,4 | 56,8 | 301102122 |
|                | biela/white                         | 24,8 | 29,7 | 301102124 |
|                | biela s krytkou/white with cover    | 36,3 | 43,5 | 301102123 |

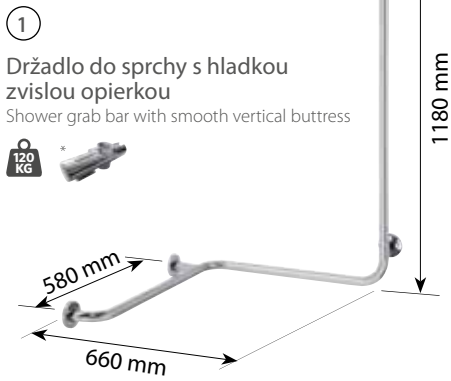

**1**  
Držadlo do sprchy s hladkou zvislou opierkou  
Shower grab bar with smooth vertical buttress



**2**  
Oporné držadlo  
Grab bar



**3**  
Nástenné oporné držadlo  
Shower grab bar

| Šírka držadla [L]<br>Product length [L]  | Povrchová úprava<br>Finish          | Cena € bez DPH<br>Price € | Cena € vč. DPH<br>Price € | Objednávkové číslo<br>Ordering number |
|--|-------------------------------------|---------------------------|---------------------------|---------------------------------------|
| <b>1</b><br>right/recht/правый           | nerez s krytkou/polished with cover | 108,7                     | 130,4                     | 301122021                             |
|  | brus s krytkou/matt with cover      | 117,0                     | 140,4                     | 301122022                             |
|  | biela/white                         | 75,3                      | 90,4                      | 301122024                             |
|  | biela s krytkou/white with cover    | 81,3                      | 97,6                      | 301122023                             |
| left/links/левый                         | nerez s krytkou/polished with cover | 108,7                     | 130,4                     | 301112021                             |
|  | brus s krytkou/matt with cover      | 117,4                     | 140,8                     | 301112022                             |
|  | biela/white                         | 75,3                      | 90,4                      | 301112024                             |
|  | biela s krytkou/white with cover    | 81,3                      | 97,6                      | 301112023                             |
| <b>2</b><br>right/recht/правый           | nerez s krytkou/polished with cover | 116,7                     | 140,0                     | 301122141                             |
|  | brus s krytkou/matt with cover      | 126,0                     | 151,2                     | 301122142                             |
|  | biela/white                         | 57,1                      | 68,5                      | 301122144                             |
|  | biela s krytkou/white with cover    | 71,7                      | 86,0                      | 301122143                             |
| left/links/левый                         | nerez s krytkou/polished with cover | 116,7                     | 140,0                     | 301112131                             |
|  | brus s krytkou/matt with cover      | 126,0                     | 151,2                     | 301112132                             |
|  | biela/white                         | 57,1                      | 68,5                      | 301112134                             |
|  | biela s krytkou/white with cover    | 71,7                      | 86,0                      | 301112133                             |
| <b>3</b><br>right/recht/правый<br>890 mm | nerez s krytkou/polished with cover | 80,1                      | 96,1                      | 301122041                             |
|  | brus s krytkou/matt with cover      | 86,4                      | 103,6                     | 301122042                             |
|  | biela/white                         | 54,3                      | 65,2                      | 301122044                             |
|  | biela s krytkou/white with cover    | 68,3                      | 82,0                      | 301122043                             |
| left/links/левый<br>890 mm               | nerez s krytkou/polished with cover | 80,1                      | 96,1                      | 301112041                             |
|  | brus s krytkou/matt with cover      | 85,7                      | 102,9                     | 301112042                             |
|  | biela/white                         | 54,3                      | 65,2                      | 301112044                             |
|  | biela s krytkou/white with cover    | 68,3                      | 82,0                      | 301112043                             |
| right/recht/правый<br>680 mm             | nerez s krytkou/polished with cover | 80,1                      | 96,1                      | 301112061                             |
|  | brus s krytkou/matt with cover      | 86,0                      | 103,2                     | 301112062                             |
|  | biela/white                         | 54,3                      | 65,2                      | 301112064                             |
|  | biela s krytkou/white with cover    | 65,8                      | 79,0                      | 301112063                             |
| left/links/левый<br>680 mm               | nerez s krytkou/polished with cover | 80,1                      | 96,1                      | 301112071                             |
|  | brus s krytkou/matt with cover      | 86,4                      | 103,6                     | 301112072                             |
|  | biela/white                         | 54,3                      | 65,2                      | 301112074                             |
|  | biela s krytkou/white with cover    | 65,8                      | 79,0                      | 301112073                             |

# HELP



- 1 Redukcia na dvere pre HELP  
Back cover for mounting on door



- 3 Sklopná sprchová sedačka  
Reversible shower seat



- 2 Sklopná sprchová sedačka s opornou nohou  
Reversible shower seat with buttress stand



- 4 Konštrukcia pre uchytenie sprchovej sedacky 347125011 do sadrokartónu  
Construction for fixing in plasterboard shower seat 347125011

| 1 | Povrchová úprava<br>Finish                                   | Cena € bez DPH<br>Price € | Cena € vč. DPH<br>Price € | Objednávkové číslo<br>Ordering number |
|---|--|---------------------------|---------------------------|---------------------------------------|
|   | nerez/stainless  | 6,8                       | 8,2                       | 131567174                             |
|   | brus/matt  | 6,8                       | 8,2                       | 131567175                             |
|   | biela/white  | 6,8                       | 8,2                       | 131567176                             |
| 2 | nerez/stainless  | 137,1                     | 164,5                     | 301102181                             |
|   | nerez s krytkou/polished with cover                          | 157,9                     | 189,5                     | 301207181                             |
|   | brus/matt  | 143,9                     | 172,7                     | 301102182                             |
|   | brus s krytkou/matt with cover                               | 162,1                     | 194,5                     | 301207182                             |
|   | biela/white  | 175,0                     | 210,0                     | 301102184                             |
|   | biela s krytkou/white with cover                             | 181,3                     | 217,6                     | 301207183                             |
| 3 | plastic, stainless/Kunststoff, Edelstahl/нержавејка, пластик | 178,3                     | 214,0                     | 347125011                             |
| 4 | steel/Stahl/сталь  | 71,5                      | 85,8                      | 347625051                             |



- 5 Sklopná sprchová sedačka  
Reversible shower seat



- 6 Výklopné zrkadlo  
Tilting mirror for disabled people



- 7 Výklopné zrkadlo  
Tilting mirror for disabled people

| Šírka držiadla [L]<br>Product length [L] | Povrchová úprava<br>Finish                                   | Cena € bez DPH<br>Price € | Cena € vč. DPH<br>Price € | Objednávkové číslo<br>Ordering number |           |
|--|--|---------------------------|---------------------------|---------------------------------------|-----------|
| 5  | plastic, stainless/Kunststoff, Edelstahl/нержавејка, пластик | 85,7                      | 102,8                     | 326325056                             |           |
| 6  | 600 x 400 mm   | nerez/stainless           | 127,0                     | 152,4                                 | 301401031 |
|  | brus/matt  | 142,8                     | 171,4                     | 301401032                             |           |
|  | biela/white  | 90,1                      | 108,1                     | 301401034                             |           |
| 7  | 600 x 600 mm   | nerez/stainless           | 147,4                     | 176,8                                 | 301401041 |
|  | brus/matt  | 164,5                     | 197,4                     | 301401042                             |           |
|  | biela/white  | 99,1                      | 118,9                     | 301401044                             |           |

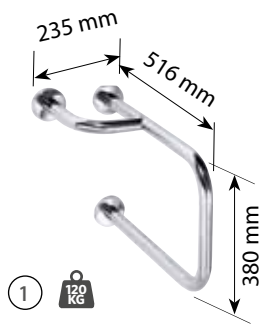

1 **Podperné držadlo**  
Grab bar



2 **Kombinovaný úchyt k umývadlu**  
Compound grab bar to sink



3 **Držadlo s poličkou**  
Handle with shelf

| Šírka držadla [L]<br>Product length [L] | Povrchová úprava<br>Finish          | Cena € bez DPH<br>Price € | Cena € vč. DPH<br>Price € | Objednávkové číslo<br>Ordering number |
|---|-------------------------------------|---------------------------|---------------------------|---------------------------------------|
| 1 right/recht/правый                    | nerez s krytkou/polished with cover | 87,7                      | 105,3                     | 301122111                             |
| 500 mm                                  | brus s krytkou/matt with cover      | 94,7                      | 113,6                     | 301122112                             |
|   | biela/white                         | 47,2                      | 56,6                      | 301122114                             |
|   | biela s krytkou/white with cover    | 63,4                      | 76,1                      | 301122113                             |
| left/links/левый                        | nerez s krytkou/polished with cover | 87,7                      | 105,3                     | 301112101                             |
| 500 mm                                  | brus s krytkou/matt with cover      | 94,7                      | 113,6                     | 301112102                             |
|   | biela/white                         | 47,2                      | 56,6                      | 301112104                             |
|   | biela s krytkou/white with cover    | 63,4                      | 76,1                      | 301112103                             |
| 2 right/recht/правый                    | nerez s krytkou/polished with cover | 103,2                     | 123,9                     | 301112161                             |
| 760 mm                                  | brus s krytkou/matt with cover      | 113,3                     | 135,9                     | 301112162                             |
|   | biela/white                         | 59,9                      | 71,8                      | 301112164                             |
|   | biela s krytkou/white with cover    | 70,0                      | 84,0                      | 301112163                             |
| left/links/левый                        | nerez s krytkou/polished with cover | 103,2                     | 123,9                     | 301112151                             |
| 760 mm                                  | brus s krytkou/matt with cover      | 113,3                     | 135,9                     | 301112152                             |
|   | biela/white                         | 59,9                      | 71,8                      | 301112154                             |
|   | biela s krytkou/white with cover    | 70,0                      | 84,0                      | 301112153                             |
| 3 580 x 220 mm                          | nerez s krytkou/polished with cover | 70,9                      | 85,0                      | 301100571                             |
|   | brus s krytkou/matt with cover      | 75,7                      | 90,8                      | 301100572                             |
|   | biela/white                         | 42,6                      | 51,2                      | 301100574                             |
|   | biela s krytkou/white with cover    | 46,7                      | 56,0                      | 301100573                             |



Pre bezbariérové kúpeľne. Ľahší pohyb a lepší komfort.

Povrchové úpravy: nerez lesk, nerez brus a komaxit biely. Veľká variabilita tvarov a rozmerov. Výrobky sú certifikované štátnou skúšobňou a zodpovedajú legislatíve o inštalácii produktov do bezbariérových priestorov.

Bathroom accessories for safe movement in your bathroom.

Finish: stainless steel polished, stainless steel matt, steel powder coated white. Wide variability of shapes and dimensions. High product quality demonstrated by certificates.

# HELP



1 120 KG

**Sedačka do vane**  
Removable and adjustable bathtub seat



2 120 KG

**Závesná sprchová sedačka**  
Shower seat, hanging on the handle



3 150 KG

**Stolička**  
Bathroom stool

| Povrchová úprava<br>Finish                                     | Cena € bez DPH<br>Price € | Cena € vč. DPH<br>Price € | Objednávkové číslo<br>Ordering number |
|--|---------------------------|---------------------------|---------------------------------------|
| 1 plastic, stainless/Kunststoff, Edelstahl/нержавејка, пластик | <b>108,7</b>              | <b>130,4</b>              | <b>338125066</b>                      |
| 2 plastic, stainless/Kunststoff, Edelstahl/нержавејка, пластик | <b>141,5</b>              | <b>169,8</b>              | <b>338125081</b>                      |
| 3 plastic, stainless/Kunststoff, Edelstahl/нержавејка, пластик | <b>122,2</b>              | <b>146,6</b>              | <b>338125071</b>                      |

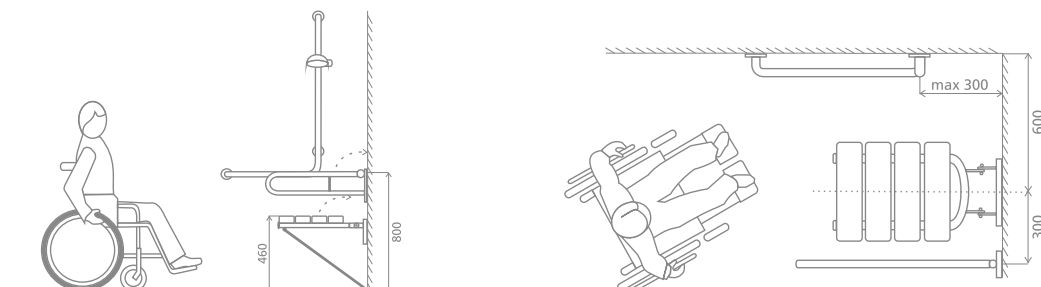
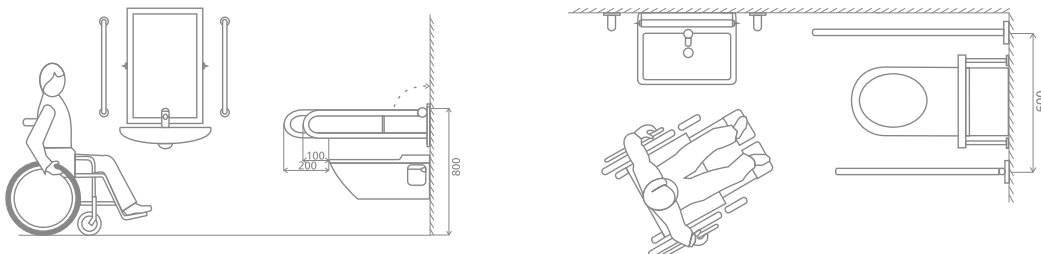
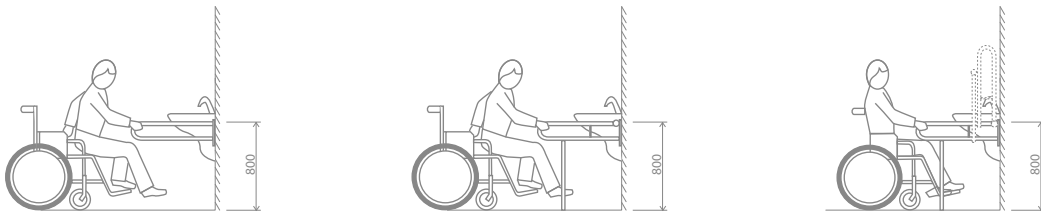
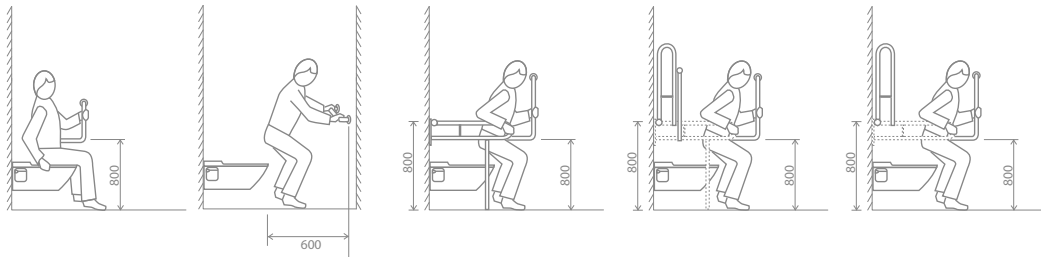
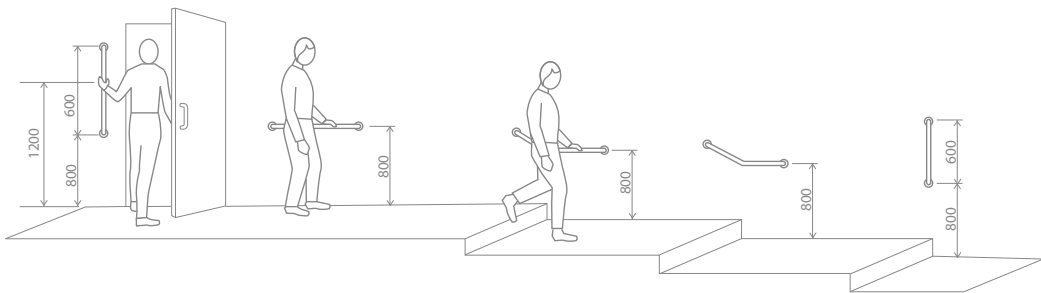



A series of horizontal dotted lines for writing notes.

POZNÁMKY/NOTE

A series of horizontal dotted lines for writing notes.

# Katalógy Bemeta /Catalogues Bemeta

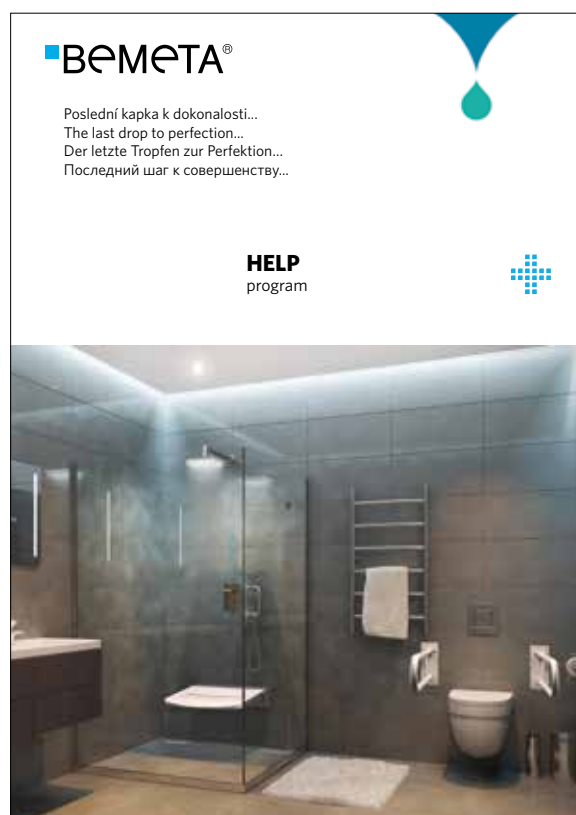

Zmeny produktov, cien, dizajnu a informácií vyhradené.  
Informácie a zobrazenia zodpovedajú času vydania katalógu. Za tlačové chyby neručíme.  
Changes in products, prices, design and informations reserved.  
Informations and images are corresponding to the time of the catalog publication. Errors and misprints excepted.

 **BEMETA**<sup>®</sup>

**BEMETA DESIGN s. r. o.**

Žatčany 28  
664 53 Česká republika

 [www.bemeta.cz](http://www.bemeta.cz)

Tel.: +420 544 224 338  
Fax: +420 544 213 040  
GSM: +420 739 201 806

 [info@bemeta.cz](mailto:info@bemeta.cz)